

AESCULAP® Ennovate® Thoracolumbar and Sacropelvic

Trays & sets guide

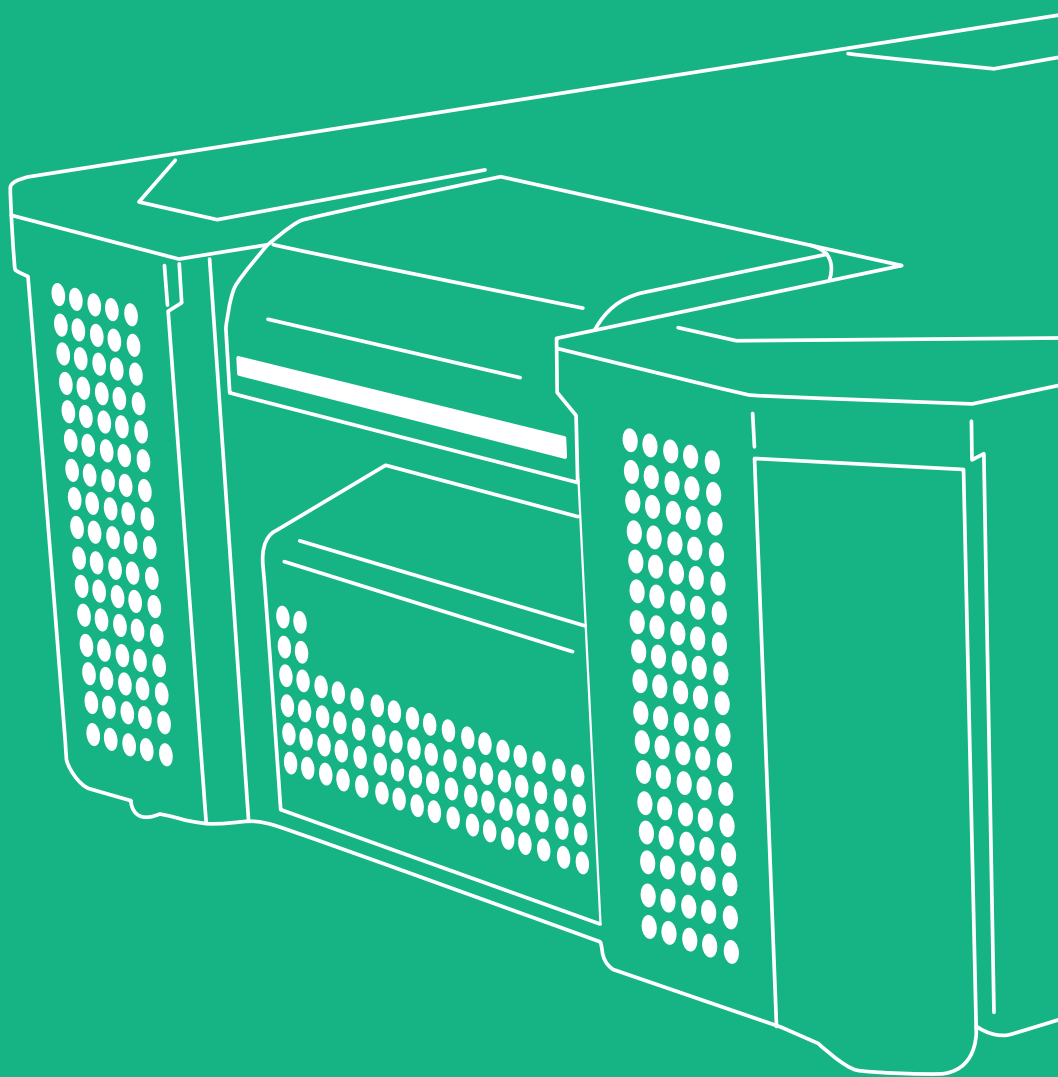

AESCULAP® Ennovate®

Thoracolumbar and Sacropelvic

Content

1	Ennovate® Cross-modular workflow	3
2	Ennovate® Spinal navigation	6
3	Ennovate® Spinal trauma	8
4	Ennovate® Open workflow	10
5	Ennovate® Minimally invasive workflow	24

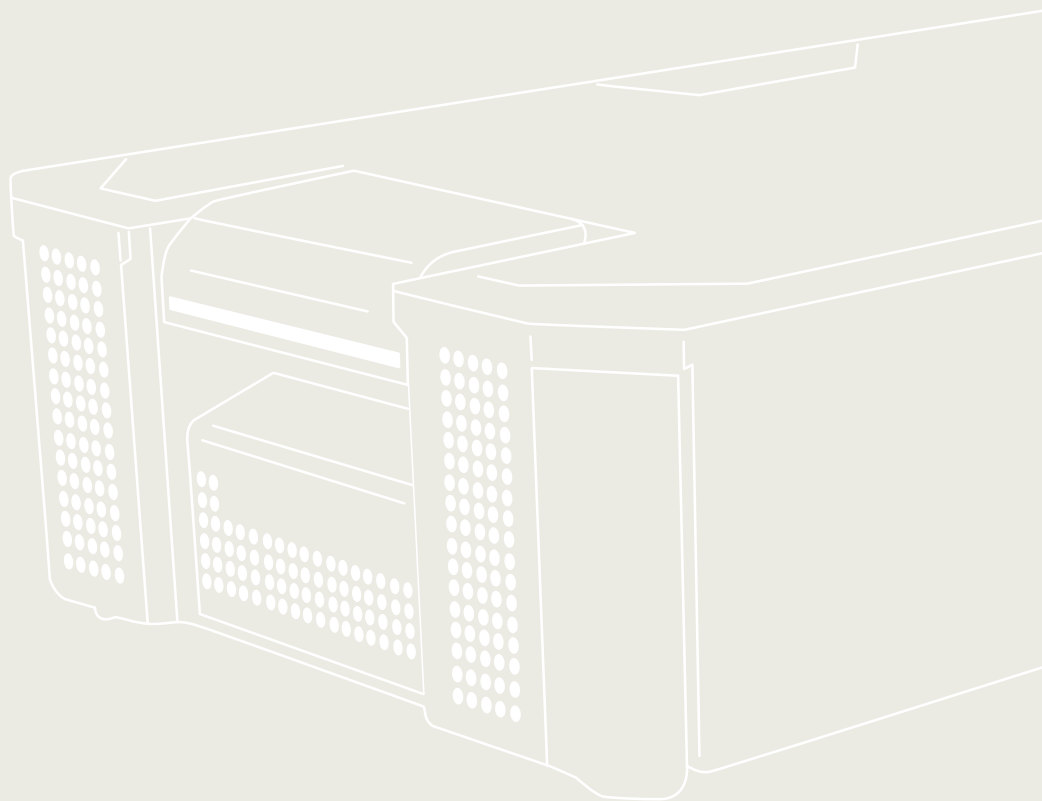

AESCULAP® Ennovate®

1 | Ennovate® tray – Guide wires

Cross-modular workflow



	Art. No.	Description	Qty.
Trays & containers	SZ204R	Ennovate® tray – Guide wires	1
Instruments	SZ369S	Ennovate® guide wire, stainless steel	*
	SZ370	Ennovate® guide wire, nitinol	*

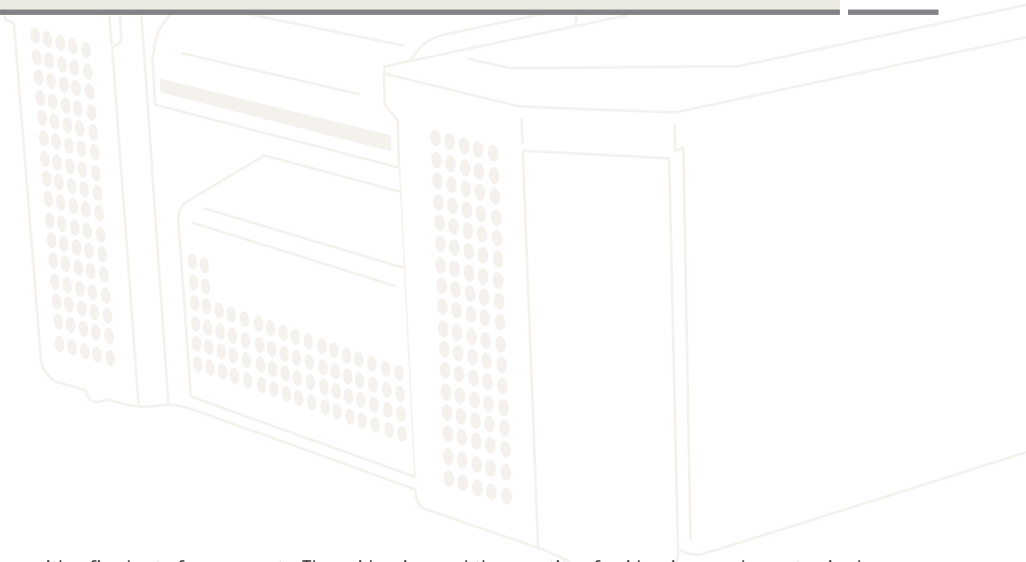

* The tray is designed for universal use and does not come with a fixed set of components. The guide wires and the quantity of guide wires can be customized and stored according to the customer's specific needs. Please note that all articles and accessories must be ordered separately to suit individual requirements.

AESCULAP® Ennovate®

1 | SZ286 Ennovate® Set – Optional instruments

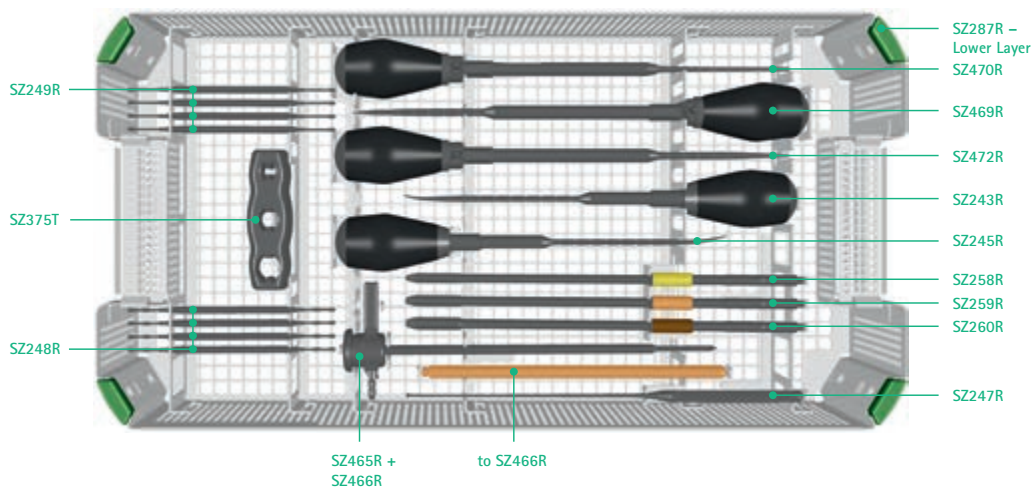

	Art. No.	Description	Qty.
Trays & containers	SZ287R	Ennovate® tray – Optional instruments	1
	JA455R	Lid for ortho tray DIN without handle	1
	JK444	Bottom for 1/1 container height: 187 mm	1
	JK487	Full-size lid with retention plate, green	1
	JG787B	Identification label, green	4
	TF294	Packing stencil for SZ287R (SZ286)	1

Instruments	SZ243R	Ennovate® lumbar pedicle probe, curved	1
	SZ245R	Ennovate® thoracic pedicle probe, curved	1
	SZ247R	Ennovate® pedicle sounder, curved	1
	SZ248R	Ennovate® pedicle marker, dual band	4
	SZ249R	Ennovate® pedicle marker, single band	4
	SZ258R	Ennovate® screw tap, Ø 8.5 mm, canulated	1
	SZ259R	Ennovate® screw tap, Ø 9.5 mm, canulated	1
	SZ260R	Ennovate® screw tap, Ø 10.5 mm, canulated	1
	SZ375T	Ennovate® MIS dilator handle	1
	SZ465R	Ennovate® guide wire trocar, navigation	1
	SZ466R	Ennovate® guide wire sleeve, navigation	1
	SZ469R	Ennovate® lumbar pedicle probe, straight, navigation, large	1
	SZ470R	Ennovate® lumbar pedicle probe, straight, navigation, canulated	1
	SZ472R	Ennovate® thoracic pedicle probe, straight, navigation, large	1

AESCULAP® Ennovate®

1 | SZ286 Ennovate® Set – Optional instruments

Cross-modular workflow

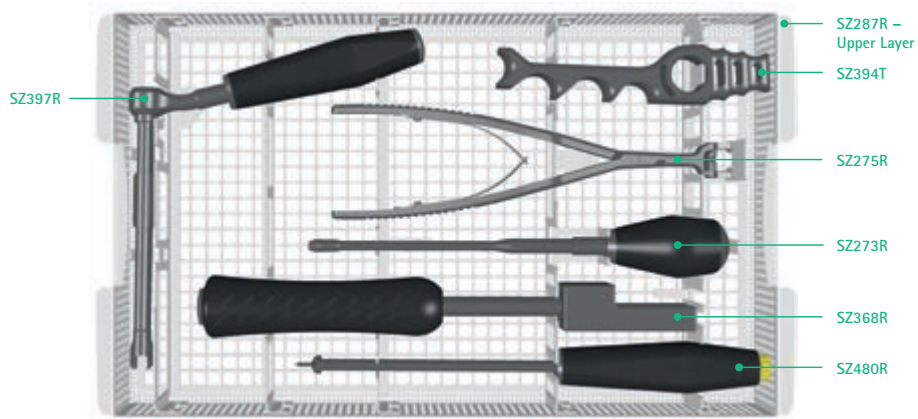

	Art. No.	Description	Qty.
Instruments	SZ397R	Ennovate® MIS quick rod pusher	1
	SZ394T	Ennovate® MIS/FRI compression/distraction device	1
	SZ275R	Ennovate® rod rocker, curved	1
	SZ273R	Ennovate® rod pusher	1
	SZ368R	Ennovate® slotted hammer	1
	SZ480R	Ennovate® cortical reamer, canulated	1

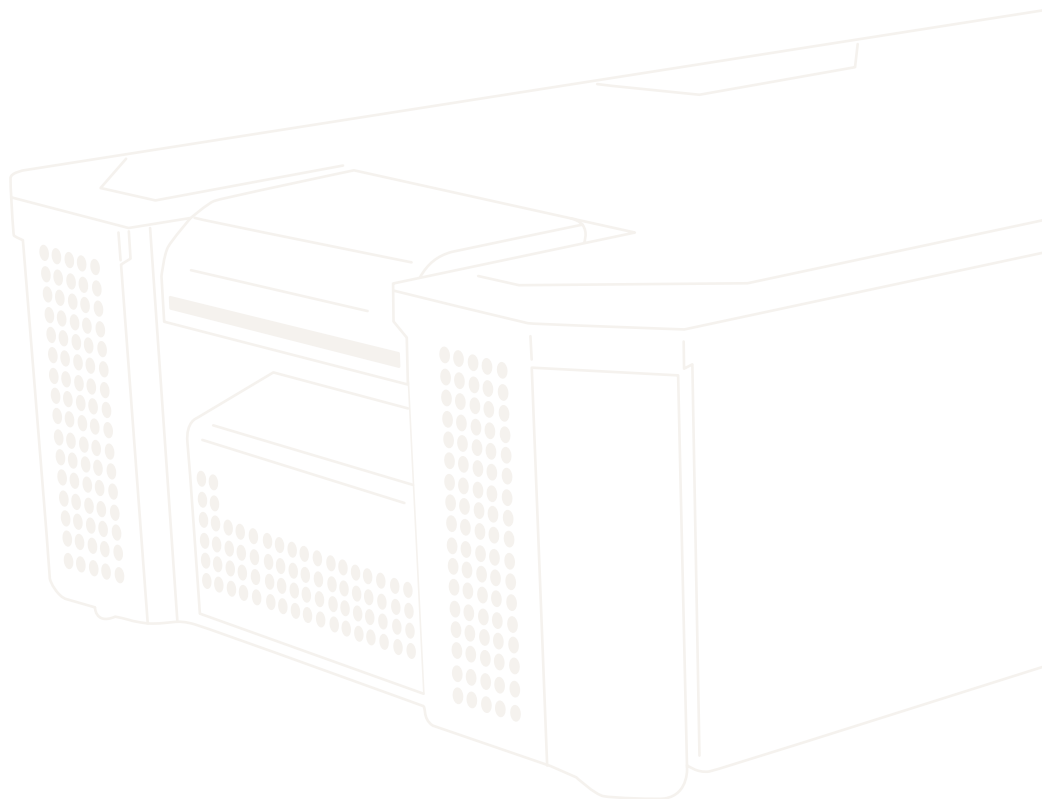

AESFULAP® Ennovate®

2 | SZ460 Ennovate® Set – Navigation adapters

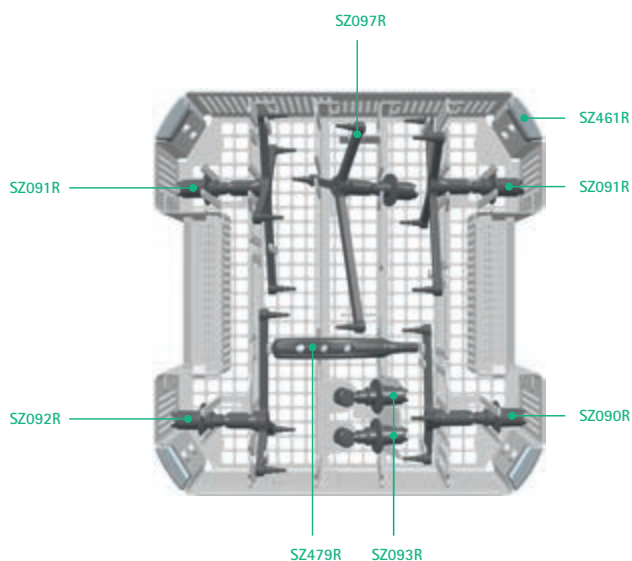

	Art. No.	Description	Qty.
Trays & containers	SZ461R	Ennovate® tray – Navigation adapters	1
	JA415R	Lid for ortho tray 1/2 without handle	1
	JK342	Bottom for 1/2 container height: 135 mm	1
	JK389	1/2 size lid with retention plate, silver	1
	JG790B	Identification label, black	4
	TF373	Packing stencil for SZ461R (SZ460)	1
Instruments	SZ090R	AESFULAP® navigation adapter, 3 marker spheres, short	1
	SZ092R	AESFULAP® navigation adapter, 3 marker spheres, long	1
	SZ097R	AESFULAP® navigation adapter, 3 marker spheres, extra long	1
	SZ091R	AESFULAP® navigation adapter, 4 marker spheres	2
	SZ093R	AESFULAP® universal navigation adapter, L shape	1
	SZ479R	Ennovate® navigation handle tightening key	1

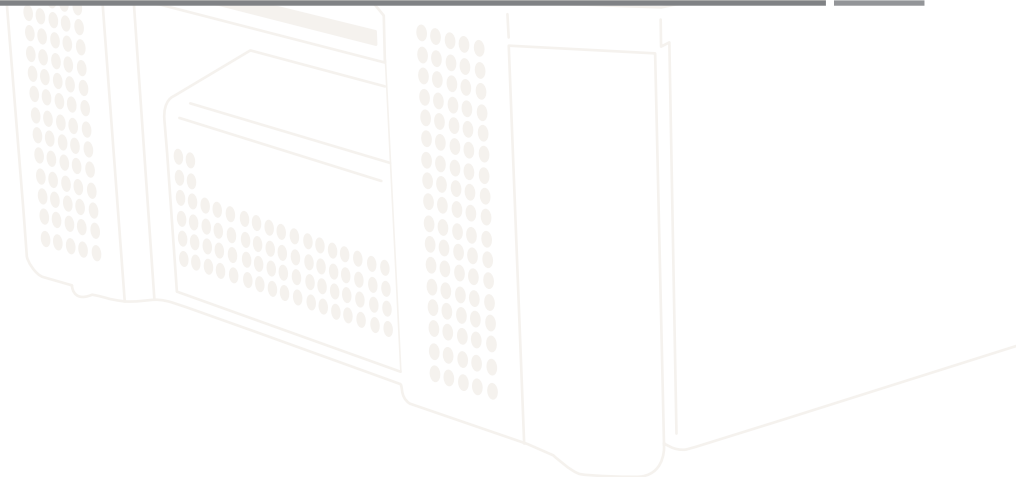

AESCULAP® Ennovate®

2 | SZ484 Ennovate® Set – Drill guide

Spinal navigation

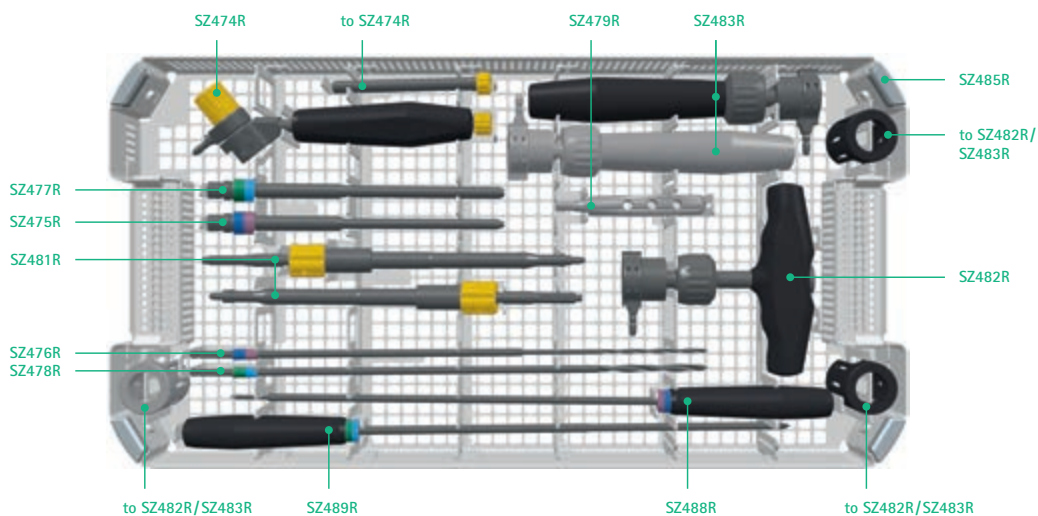

	Art. No.	Description	Qty.
Trays & containers	SZ485R	Ennovate® tray – Drill guide	1
	JA455R	Lid for ortho tray DIN without handle	1
	JK441	Bottom for 1/1 container height: 120 mm	1
	JK489	Full-size lid with retention plate, silver	1
	JG790B	Identification label, black	4
	TF375	Packing stencil for SZ485R (SZ484)	1

Instruments	SZ483R	Ennovate® navigation ratchet handle, straight	1
	SZ482R	Ennovate® navigation ratchet handle, T shape	1
	SZ481R	Ennovate® screwdriver, canulated	2
	SZ474R	Ennovate® navigation drill guide handle	1
	SZ475R	Ennovate® navigation drill guide tube for Ø 4.5/5.5 mm screws	1
	SZ488R	Ennovate® drill guide trocar for Ø 4.5/5.5 mm screws	1
	SZ476R	Ennovate® drill for Ø 4.5/5.5 mm screws, reusable, limited usage	1
	SZ477R	Ennovate® navigation drill guide tube for Ø 6.5/7.5 mm screws	1
	SZ489R	Ennovate® drill guide trocar for Ø 6.5/7.5 mm screws	1
	SZ478R	Ennovate® drill for Ø 5.5/6.5 mm screws, reusable, limited usage	1

AESCULAP® Ennovate®

3 | SZ400 Ennovate® Set – Hybrid spinal trauma

Spinal trauma

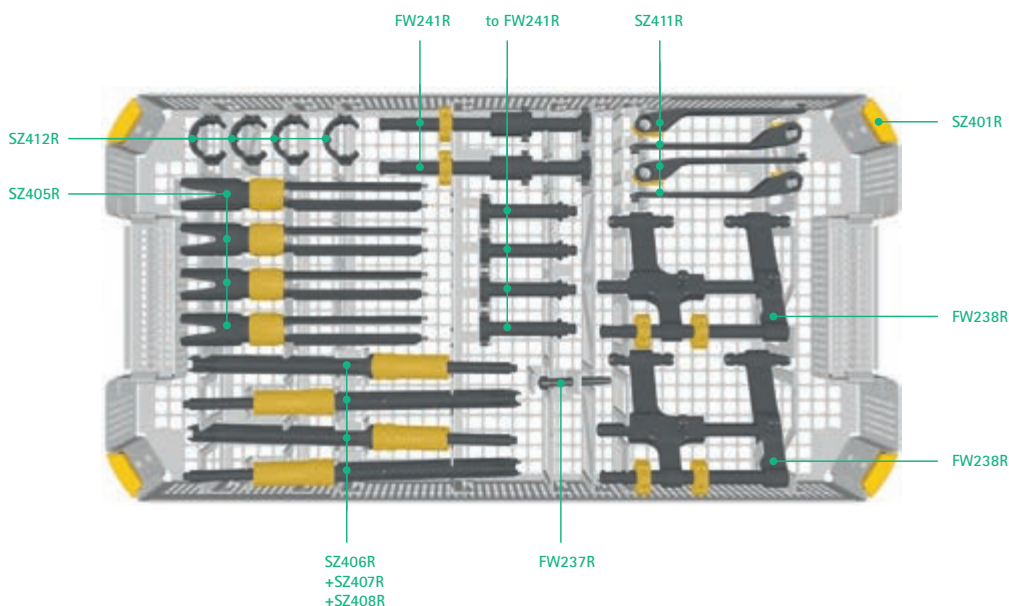

	Art. No.	Description	Qty.
Trays & containers	SZ401R	Ennovate® tray – Spinal trauma	1
	JA455R	Lid for ortho tray DIN without handle	1
	JK444	Bottom for 1/1 container height: 187 mm	1
	JK488	Full-size lid with retention plate, gold	1
	JG788B	Identification label, gold	4
	TF304	Packing stencil for SZ401R (SZ400)	1
Instruments	SZ405R	Ennovate® FRI downtube	4
	SZ406R	Ennovate® FRI insert pusher	4
	SZ407R	Ennovate® FRI rod pusher	4
	SZ408R	Ennovate® FRI rod pusher set screw driver	4
	FW238R	Ennovate® FRI parallel distractor	2
	SZ411R	Ennovate® MIS/FRI parallel distractor arms	4
	FW241R	Ennovate® FRI spindle distractor	2
	SZ412R	Ennovate® FRI spindle distractor rings	4
	FW237R	Ennovate® FRI fixation nut wrench	1

AESCULAP® Ennovate®

3 | SZ402 Ennovate® Set – Open spinal trauma

Spinal trauma

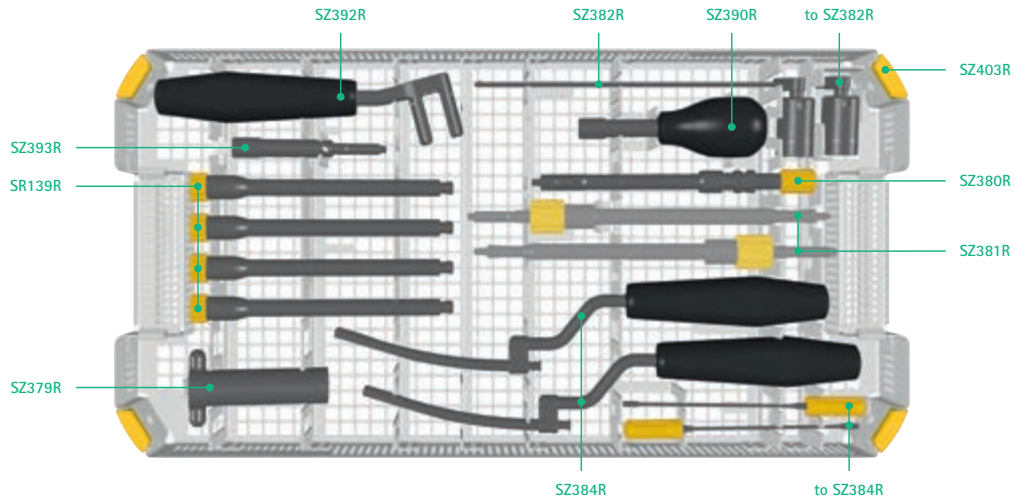

	Art. No.	Description	Qty.
Trays & containers	SZ403R	Ennovate® tray open – Spinal trauma	1
	JA455R	Lid for ortho tray DIN without handle	1
	JK441	Bottom for 1/1 container height: 120 mm	1
	JK488	Full-size lid with retention plate, gold	1
	JG788B	Identification label, gold	4
	TF302	Packing stencil for SZ403R (SZ402)	1
Instruments	SZ392R	Ennovate® counter torque handle, O shape	1
	SZ382R	Ennovate® MIS/FRI rod length caliper	1
	SZ393R	Ennovate® MIS/FRI downtube PolyLock® key	1
	SZ390R	Ennovate® reduction handle	1
	SR139R	Ennovate® cannula sleeve, minimally invasive workflow	4
	SZ380R	Ennovate® MIS/FRI downtube removal key	1
	SZ379R	Ennovate® MIS/FRI downtube tightening key	1
	SZ384R	Ennovate® MIS/FRI rod inserter, short constructs	2

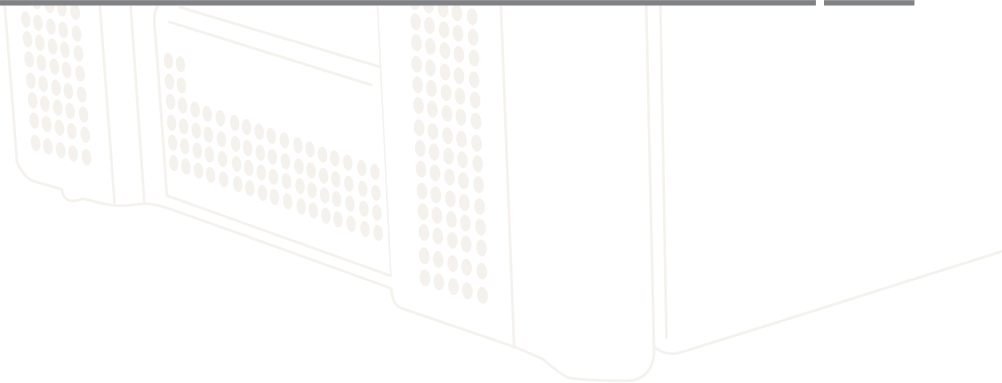

AESCULAP® Ennovate®

4 | SZ462 Ennovate® Set – Preparation and implantation

Open workflow

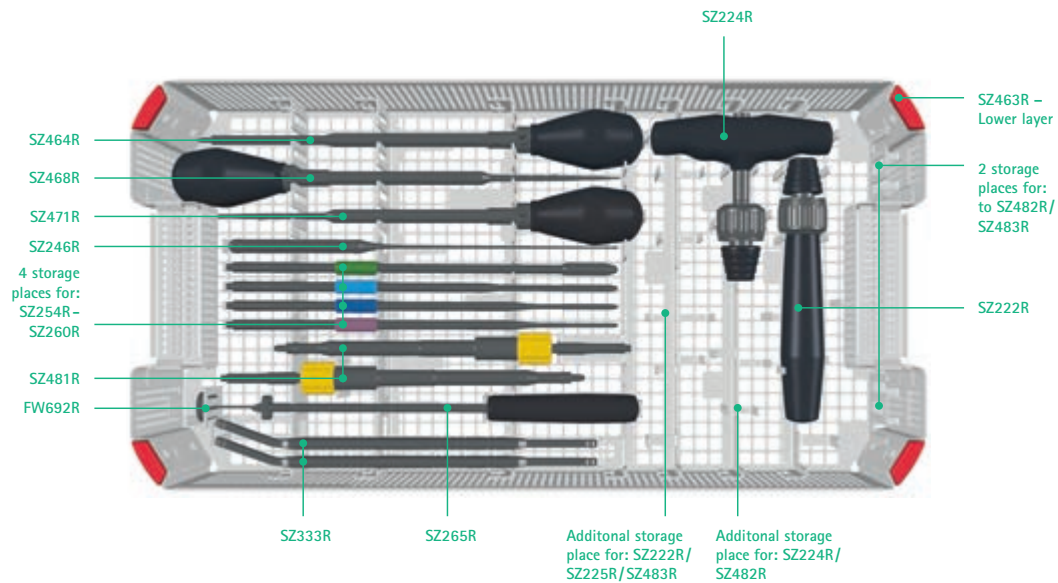

	Art. No.	Description	Qty.
Trays & containers	SZ463R	Ennovate® tray open – Preparation and implantation	1
	JA455R	Lid for ortho tray DIN without handle	1
	JK444	Bottom for 1/1 container height: 187 mm	1
	JK485	Full-size lid with retention plate, red	1
	JG785B	Identification label, red	4
	TF374	Packing Stencil for SZ463R (SZ462)	1
Instruments	SZ222R	Ennovate® ratchet handle, straight	1
	SZ224R	Ennovate® ratchet handle, T shape	1
	SZ464R	Ennovate® pedicle awl, navigation	1
	SZ468R	Ennovate® lumbar pedicle probe, straight, navigation	1
	SZ471R	Ennovate® thoracic pedicle probe, straight, navigation	1
	SZ246R	Ennovate® pedicle sounder, straight	1
	SZ254R	Ennovate® screw tap, Ø 4.5 mm, canulated	1
	SZ255R	Ennovate® screw tap, Ø 5.5 mm, canulated	1
	SZ256R	Ennovate® tap, Ø 6.5 mm, canulated	1
	SZ257R	Ennovate® screw tap, Ø 7.5 mm, canulated	1
	SZ481R	Ennovate® screwdriver, canulated	2
	SZ265R	Ennovate® screw body manipulator	1
	SZ333R	Ennovate® rod rotation wrench	2
	FW692R	Ennovate® canulation cleaning device	1

AESCULAP® Ennovate®

4 | SZ462 Ennovate® Set – Preparation and implantation

Open workflow

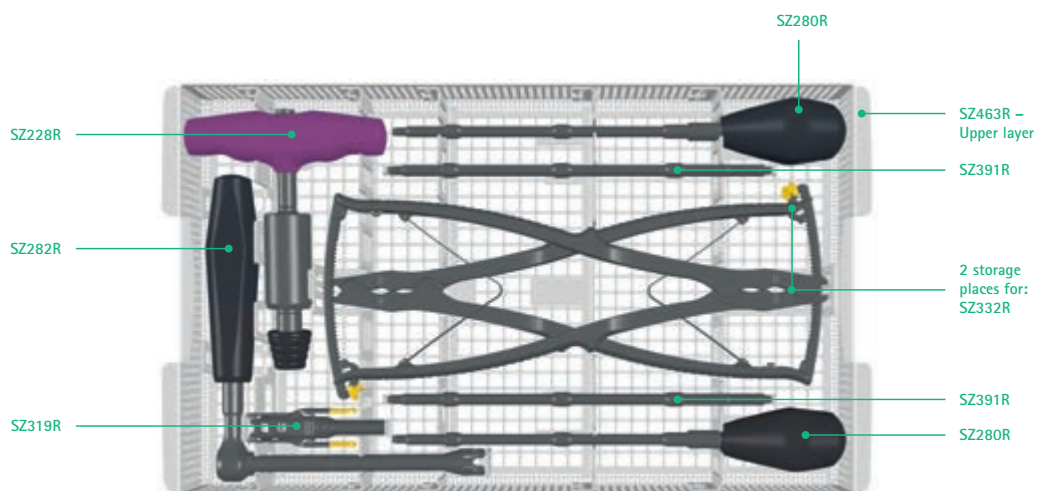

	Art. No.	Description	Qty.
Instruments	SZ228R	Ennovate® torque handle, 10 Nm	1
	SZ282R	Ennovate® counter torque handle for final tightening	1
	SZ332R	Ennovate® rod gripper	2
	SZ391R	Ennovate® set screw driver, with AESCULAP® hexagon	2
	SZ280R	Ennovate® set screw driver, with handle	2
	SZ319R	Ennovate® set screw centralizer	0

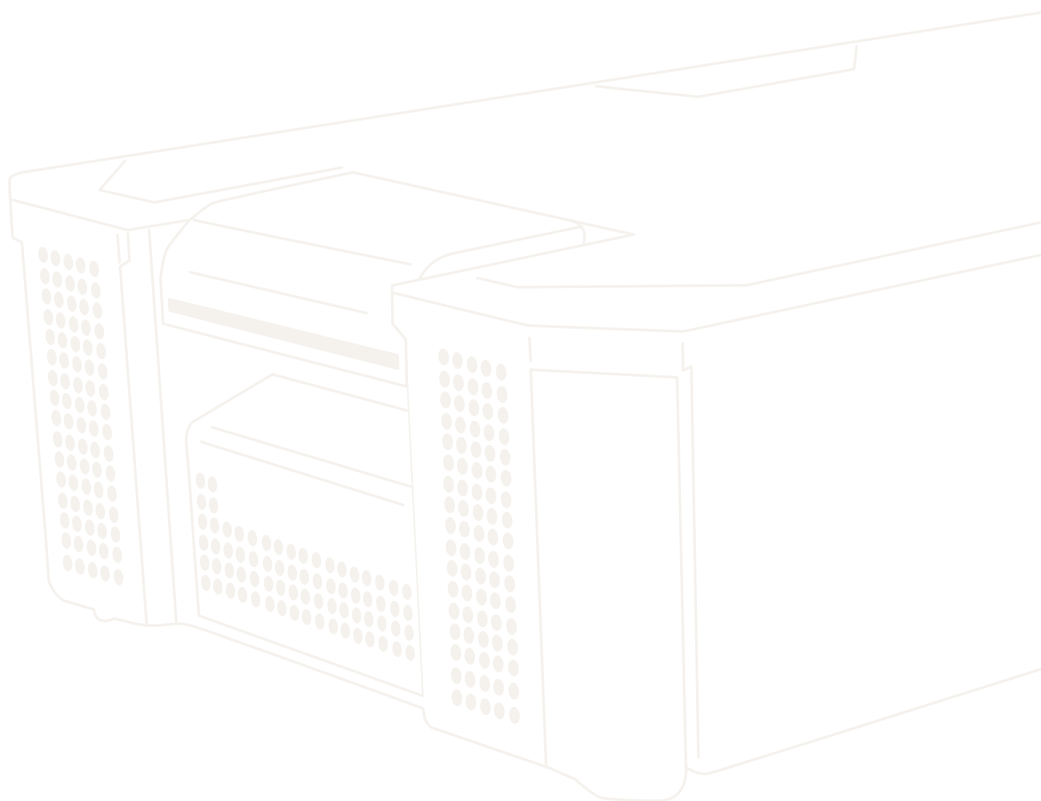

AESFULAP® Ennovate®

4 | SZ250 Ennovate® Set – Rod reduction and compression/distraction

Open workflow

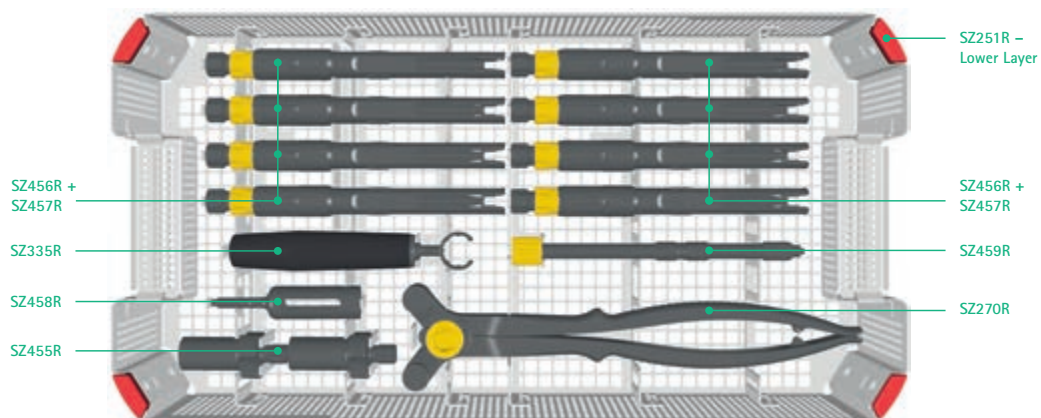

	Art. No.	Description	Qty.
Trays & containers	SZ251R	Ennovate® tray open – Rod reduction and compression/distraction	1
	JA455R	Lid for ortho tray DIN without handle	1
	JK444	Bottom for 1/1 container height: 187 mm	1
	JK485	Full-size lid with retention plate, red	1
	JG785B	Identification label, red	4
	TF300	Packing stencil for SZ251R (SZ250)	1

	SZ270R	Ennovate® rod bender	1
	SZ456R	Ennovate® rod reducer rod pusher	8
	SZ455R	Ennovate® rod reducer tightening key	2
	SZ457R	Ennovate® rod reducer removal key	8
	SZ458R	Ennovate® rod reducer PolyLock® key	1
	SZ459R	Ennovate® rod reducer removal key	1
	SZ335R	Ennovate® counter torque handle, C shape	1

AESCULAP® Ennovate®

4 | SZ250 Ennovate® Set – Rod reduction and compression/distraction

Open workflow

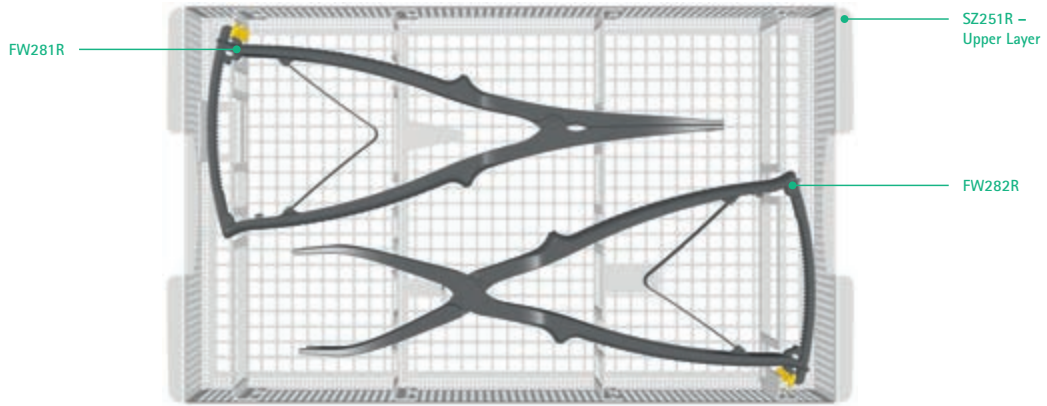

	Art. No.	Description	Qty.
Instruments	FW281R	Ennovate® distraction forceps, open workflow	1
	FW282R	Ennovate® compression forceps, open workflow	1

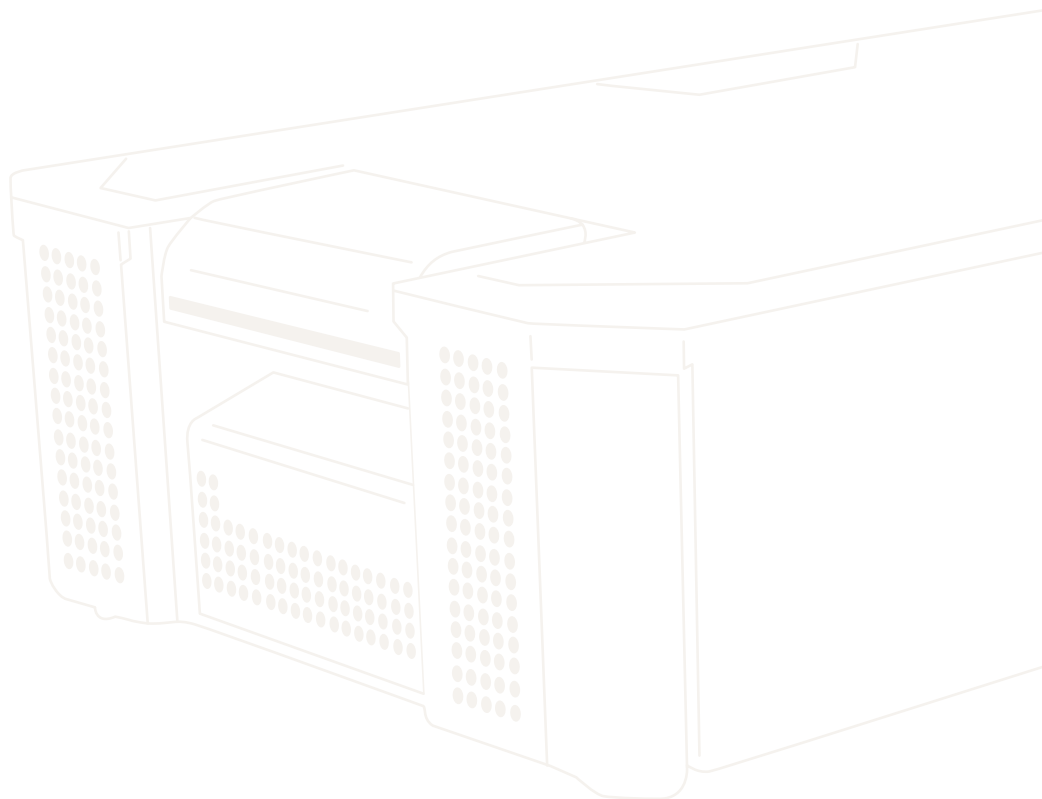

AESCULAP® Ennovate®

4 | SZ288 Ennovate® Set – Rod cutting

Open workflow

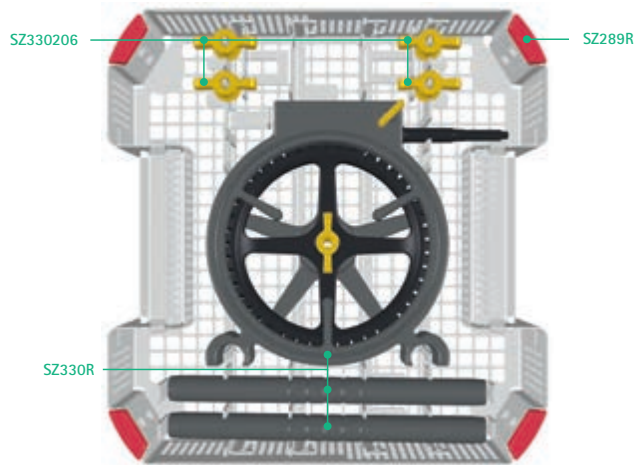

	Art. No.	Description	Qty.
Trays & containers	SZ289R	Ennovate® tray – Rod cutting	1
	JA415R	Lid for Ortho Tray 1/2 without handle	1
	JK341	Bottom for 1/2 container height: 120 mm	1
	JK385	1/2 lid with retention plate, red	1
	JG785B	Identification label, red	4
	TF295	Packing stencil for SZ289R (SZ288)	1
Instruments	SZ330R	Ennovate® rod cutter	1
	SZ330206	Ennovate® rod cutter bushing	4

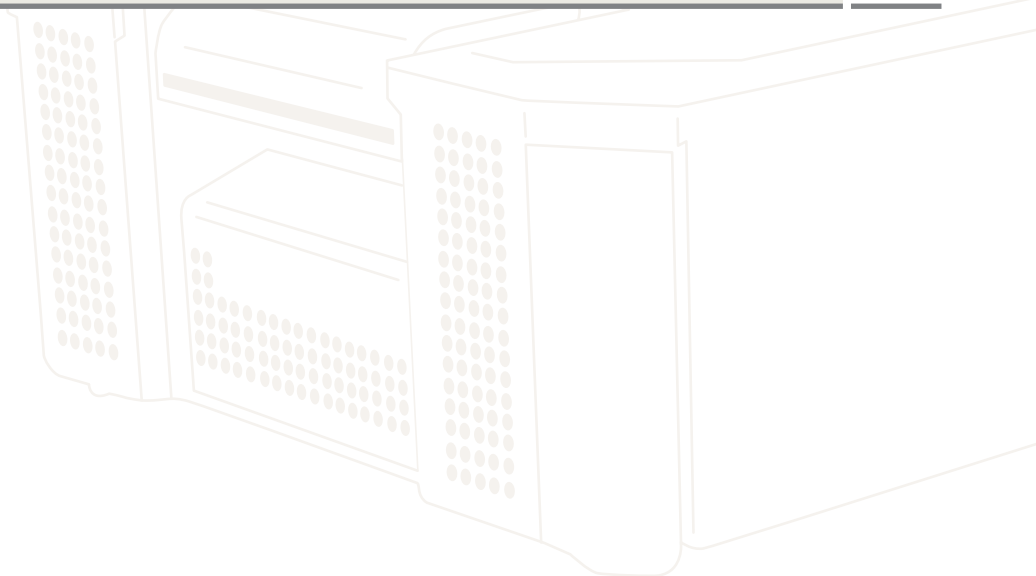

AESCU LAP® Ennovate®

4 | SZ298 Ennovate® Set open – Connector instruments

Open workflow

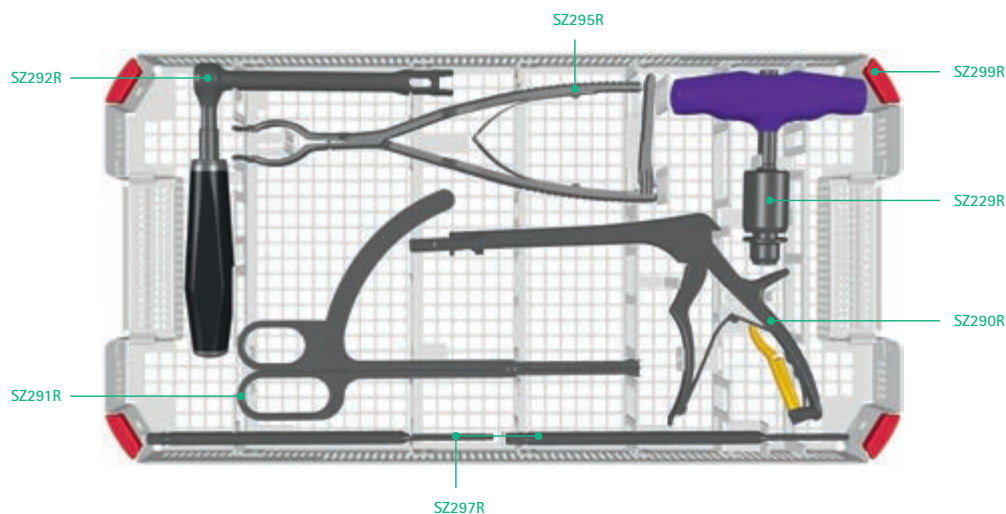

	Art. No.	Description	Qty.
Trays & containers	SZ299R	Ennovate® tray open – Connector instruments	1
	JA455R	Lid for ortho tray DIN without handle	1
	JK441	Bottom for 1/1 container height: 120 mm	1
	JK485	Full-size lid with retention plate, red	1
	JG785B	Identification label, red	4
	TF309	Packing Stencil for SZ299R (SZ298)	1
Instruments	SZ291R	Ennovate® connector caliper	1
	SZ290R	Ennovate® cross connector holder	1
	SZ295R	Ennovate® rod connector holder	1
	SZ292R	Ennovate® counter torque handle for connectors	1
	SZ229R	Ennovate® torque handle, 5 Nm	1
	SZ297R	Ennovate® torque wrench shaft for connectors	2

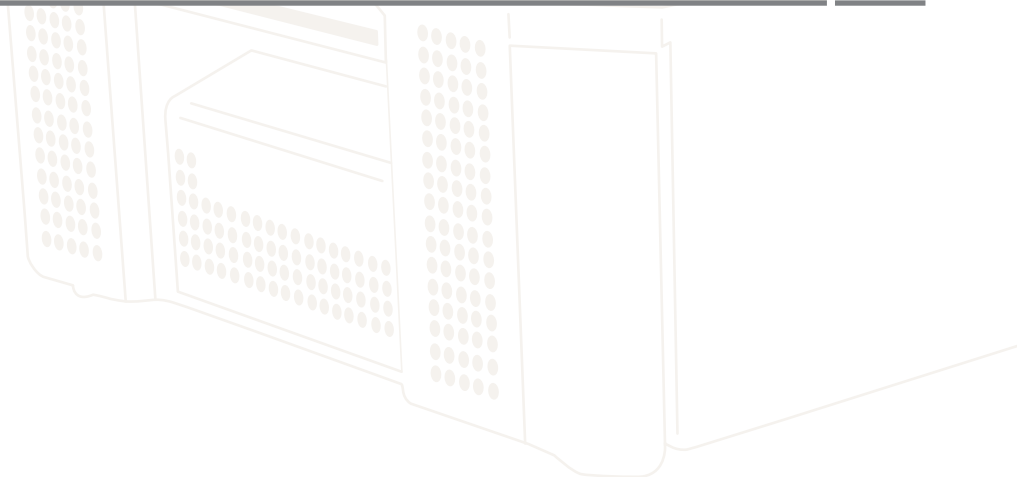

AESCULAP® Ennovate®

4 | SZ205 Ennovate® Set open – Hook instruments

Open workflow

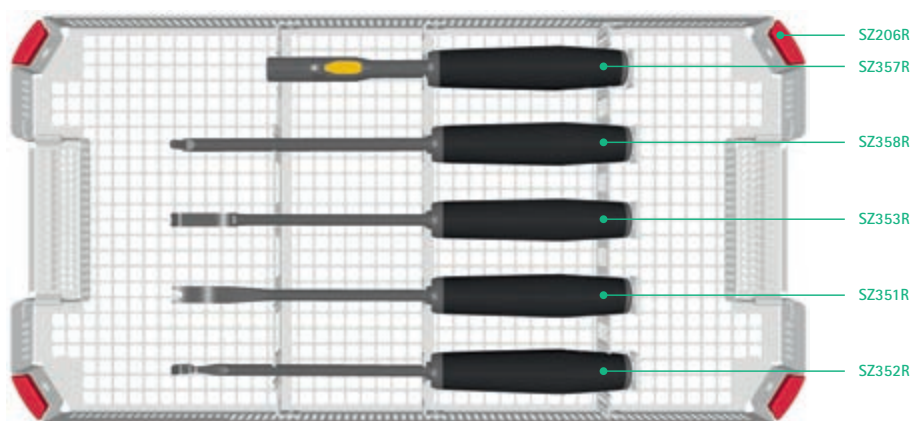

	Art. No.	Description	Qty.
Trays & containers	SZ206R	Ennovate® tray open – Hook instruments	1
	JA455R	Lid for ortho tray DIN without handle	1
	JK441	Bottom for 1/1 container height: 120 mm	1
	JK485	Full-size lid with retention plate, red	1
	JG785B	Identification label, red	4
	TF296	Packing stencil for SZ206R (SZ205)	1

Instruments	SZ351R	Ennovate® pedicle preparator	1
	SZ352R	Ennovate® lamina elevator	1
	SZ353R	Ennovate® transverse process elevator	1
	SZ357R	Ennovate® hook holder tube	1
	SZ358R	Ennovate® hook pusher	1

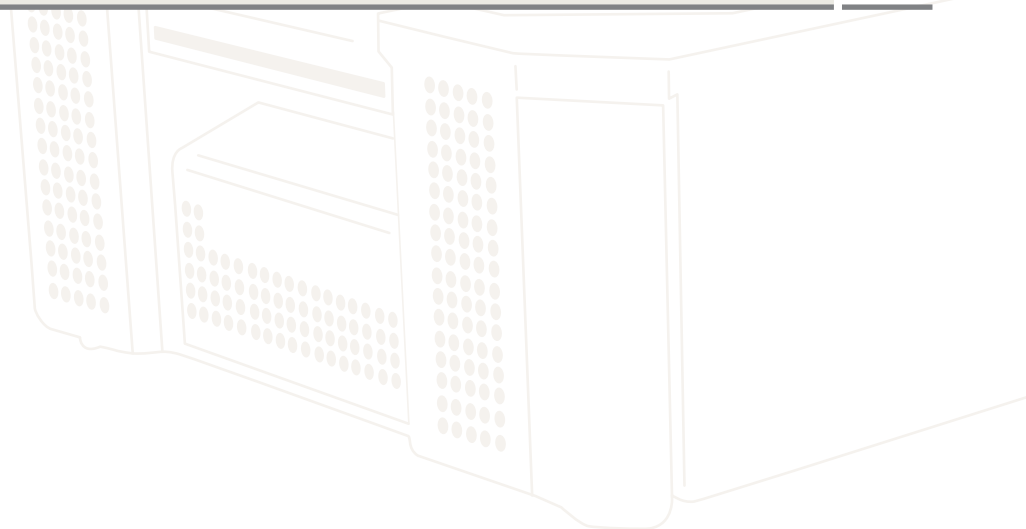

AESCULAP® Ennovate®

4 | SZ220 Ennovate® Set open – Below screw head compression/distraction

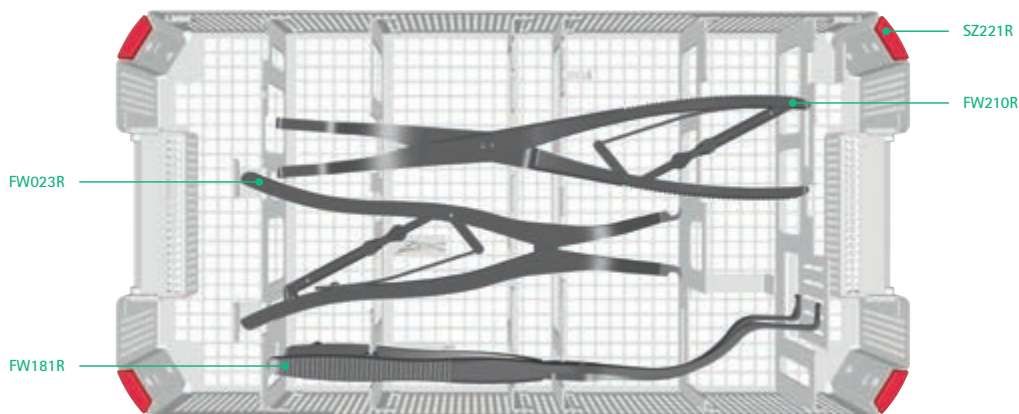

Open workflow

	Art. No.	Description	Qty.
Trays & containers	SZ221R	Ennovate® tray open – Below screw head compression/distraction	1
	JA455R	Lid for ortho tray DIN without handle	1
	JK444	Bottom for 1/1 container height: 187 mm	1
	JK485	Full-size lid with retention plate, red	1
	JG785B	Identification label, red	4
	TF301	Packing stencil for SZ221R (SZ220)	1
Instruments	FW181R	Ennovate® below screw head distraction forceps	1
	FW023R	Ennovate® below screw head distraction forceps, small	1
	FW210R	Ennovate® below screw head compression forceps	1

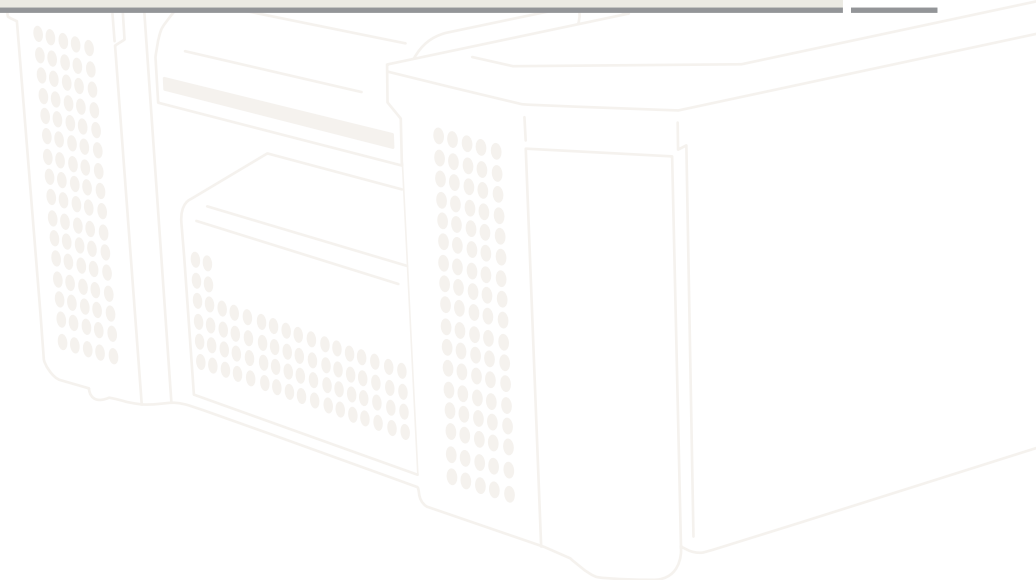

AESCULAP® Ennovate®

4 | SZ324 Ennovate® Set open – Spinal derotation

Open | Complex spine

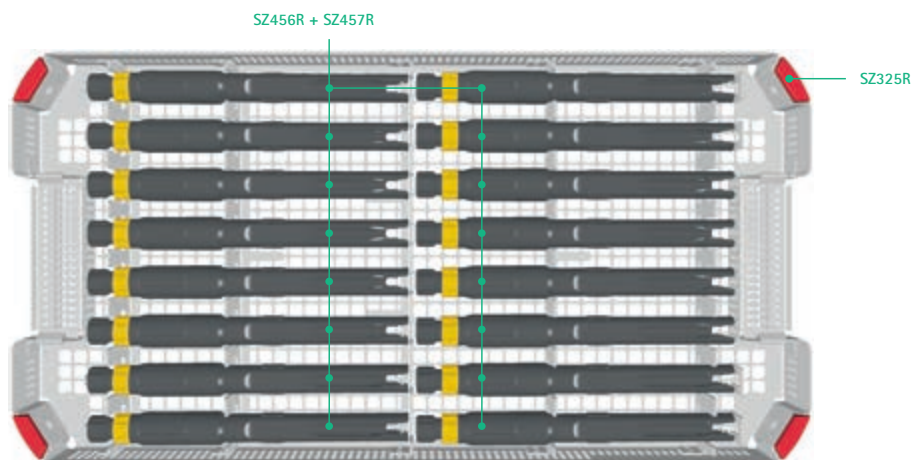

	Art. No.	Description	Qty.
Trays & containers	SZ325R	Ennovate® tray open – Spinal derotation	1
	JA455R	Lid for ortho tray DIN without handle	1
	JK441	Bottom for 1/1 container height: 120 mm	1
	JK485	Full-size lid with retention plate, red	1
	JG793B	Identification label, purple	4
	TF307	Packing stencil for SZ325R (SZ324)	1
Instruments	SZ456R	Ennovate® rod reducer tube	16
	SZ457R	Ennovate® rod reducer rod pusher	16

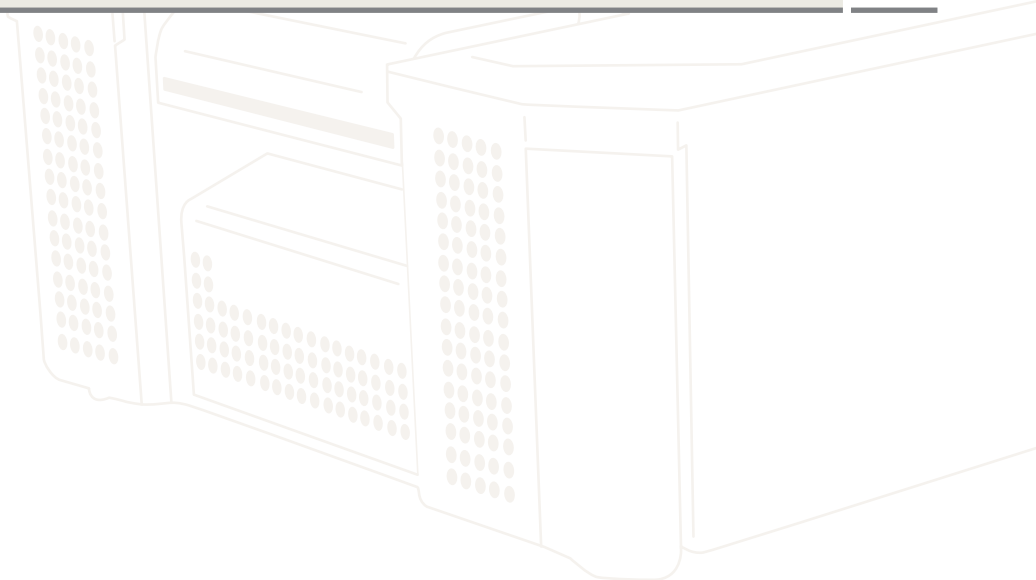

AESCULAP® Ennovate®

4 | SZ326 Ennovate® Set open – Spinal triangulation

Open | Complex spine

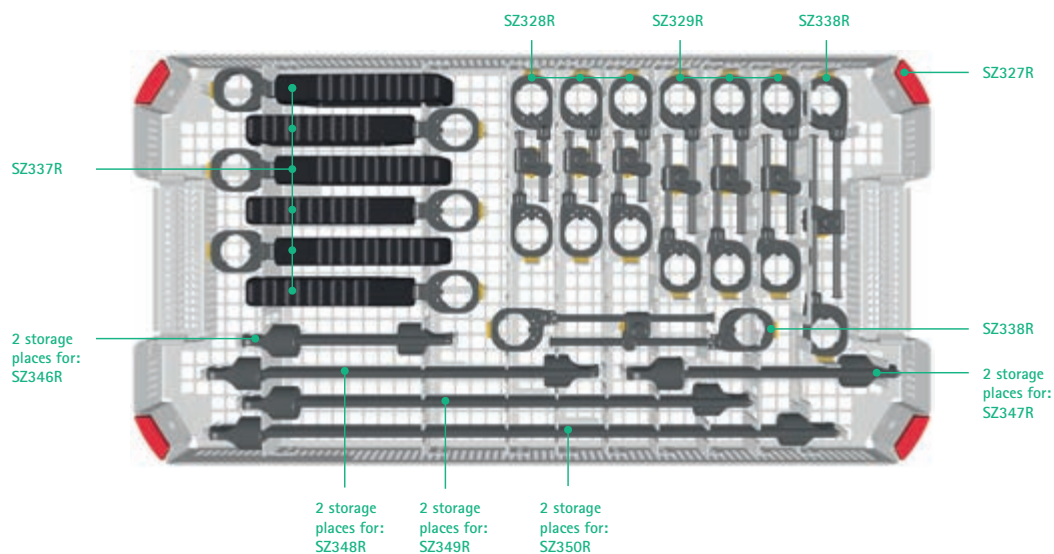

	Art. No.	Description	Qty.
Trays & containers	SZ327R	Ennovate® tray open – Spinal triangulation	1
	JA455R	Lid for ortho tray DIN without handle	1
	JK441	Bottom for 1/1 container height: 120 mm	1
	JK485	Full-size lid with retention plate, red	1
	JG793B	Identification label, purple	4
	TF308	Packing stencil for SZ327R (SZ326)	1

Instruments	SZ337R	Ennovate® derotation handle	6
	SZ328R	Ennovate® derotation link, S	3
	SZ329R	Ennovate® derotation link, M	3
	SZ338R	Ennovate® derotation link, L	2
	SZ346R	Ennovate® derotation pin, S	2
	SZ347R	Ennovate® derotation pin, M	2
	SZ348R	Ennovate® derotation pin, L	2
	SZ349R	Ennovate® derotation pin, XL	2
	SZ350R	Ennovate® derotation pin, XXL	2

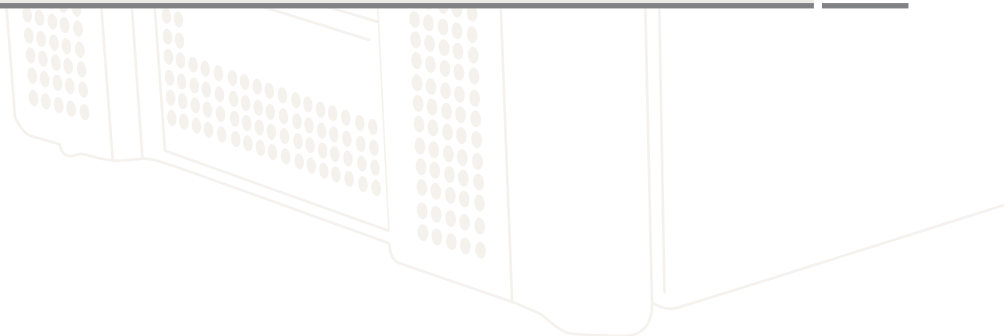

AESCULAP® Ennovate®

4 | SZ320 Ennovate® Set open – In-situ rod contouring

Open | Complex spine

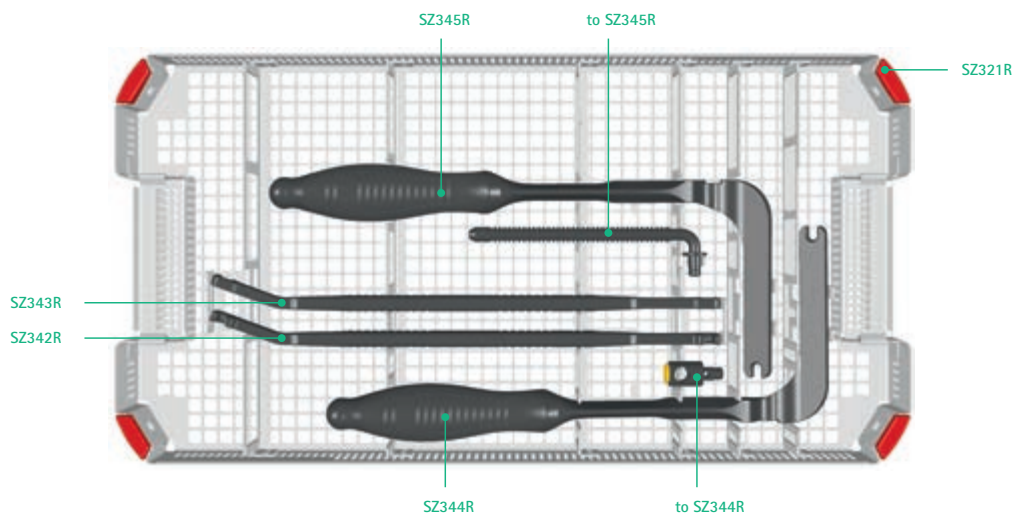

	Art. No.	Description	Qty.
Trays & containers	SZ321R	Ennovate® tray open – In-situ rod contouring	1
	JA455R	Lid for ortho tray DIN without handle	1
	JK441	Bottom for 1/1 container height: 120 mm	1
	JK485	Full-size lid with retention plate, red	1
	JG793B	Identification label, purple	4
	TF305	Packing stencil for SZ321R (SZ320)	1
Instruments	SZ342R	Ennovate® sagittal rod bender, left	1
	SZ343R	Ennovate® sagittal rod bender, right	1
	SZ344R	Ennovate® coronal rod bender, left	1
	SZ345R	Ennovate® coronal rod bender, right	1

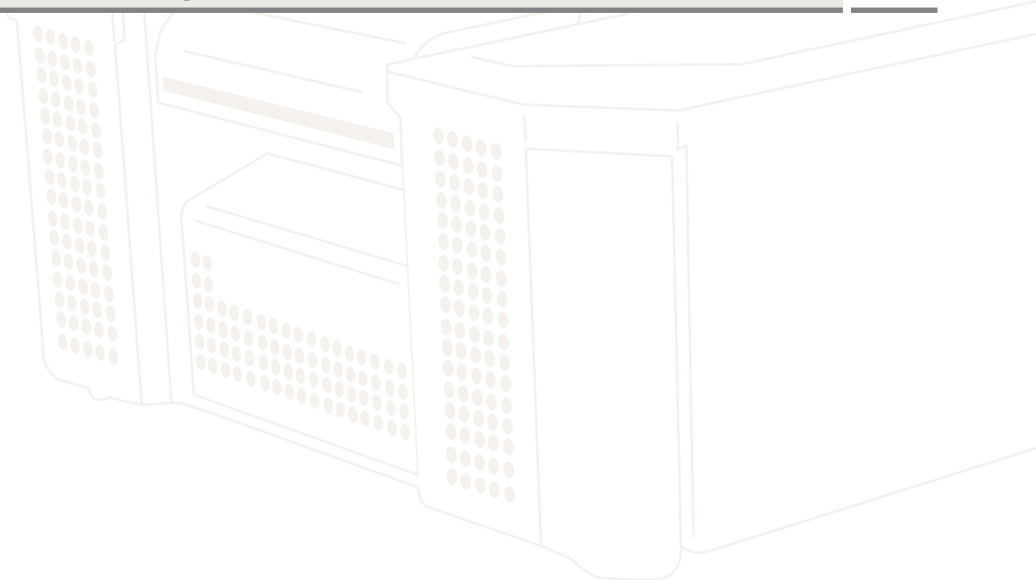

AESCULAP® Ennovate®

4 | SZ420 Ennovate® Set open – Osteotomy

Open | Complex spine

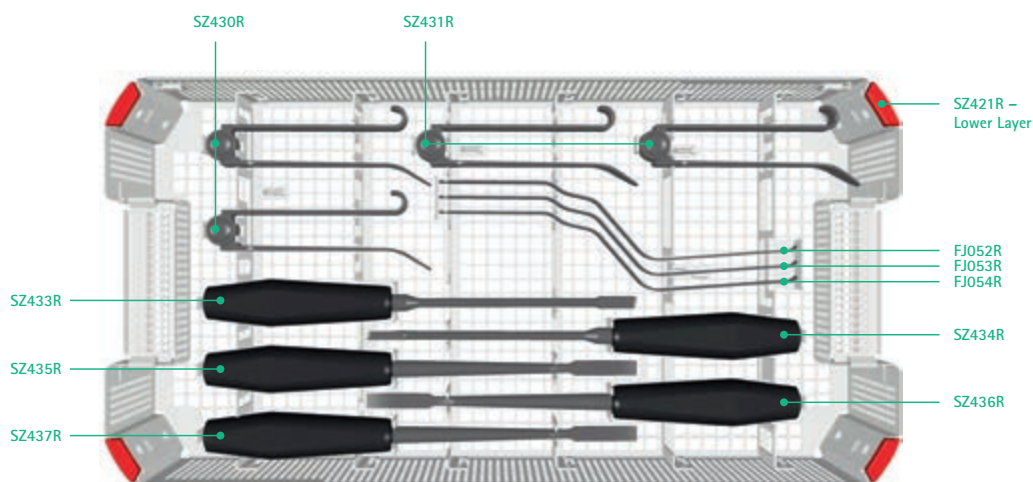

	Art. No.	Description	Qty.
Trays & containers	SZ421R	Ennovate® tray open – Osteotomy	1
	JA455R	Lid for ortho tray DIN without handle	1
	JK444	Bottom for 1/1 container height: 187 mm	1
	JK485	Full-size lid with retention plate, red	1
	JG793B	Identification label, purple	4
	TF371	Packing stencil for SZ421R (SZ420)	1

Instruments	SZ430R	Ennovate® vertebral body retractor, 15 mm	2
	SZ431R	Ennovate® vertebral body retractor, 20 mm	2
	FJ052R	PROSPACE® PLIF retractor, size M	1
	FJ053R	PROSPACE® PLIF retractor, size L	1
	FJ054R	PROSPACE® PLIF retractor, size XL	1
	SZ433R	Ennovate® L-osteotome, 6 mm x 8 mm	1
	SZ434R	Ennovate® L-osteotome, 8 mm x 6 mm	1
	SZ435R	Ennovate® osteotome, straight, 6 mm	1
	SZ436R	Ennovate® osteotome, straight, 10 mm	1
	SZ437R	Ennovate® osteotome, straight, 13 mm	1

AESCULAP® Ennovate®

4 | SZ420 Ennovate® Set open – Osteotomy

Open | Complex spine

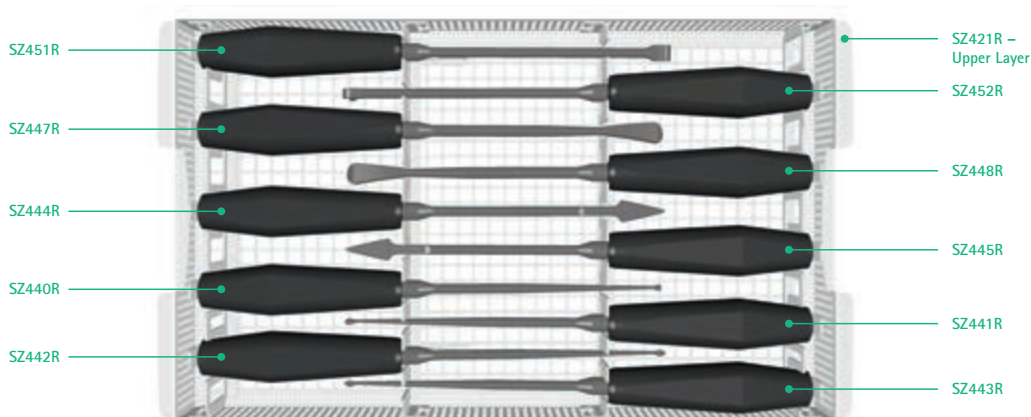

	Art. No.	Description	Qty.
Instruments	SZ440R	Ennovate® curette, straight, small	1
	SZ441R	Ennovate® curette, straight, large	1
	SZ442R	Ennovate® curette, curved, 45°, small	1
	SZ443R	Ennovate® curette, curved, 45°, large	1
	SZ447R	Ennovate® elevator, curved, 6 mm	1
	SZ448R	Ennovate® elevator, curved, 10 mm	1
	SZ444R	Ennovate® triangle shaver, 25°	1
	SZ445R	Ennovate® triangle shaver, 30°	1
	SZ451R	Ennovate® posterior wall punch, 20 mm	1
	SZ452R	Ennovate® posterior wall punch, 20 mm, large	1

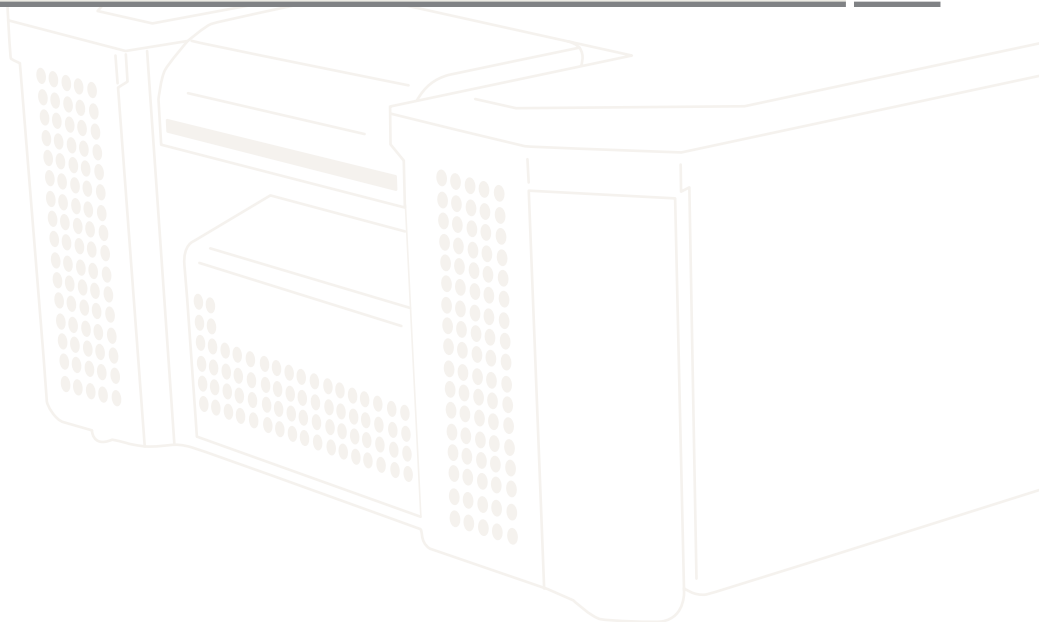

AESCULAP® Ennovate®

4 | SZ422 Ennovate® Set open - Osteotomy optional instruments

Open | Complex spine

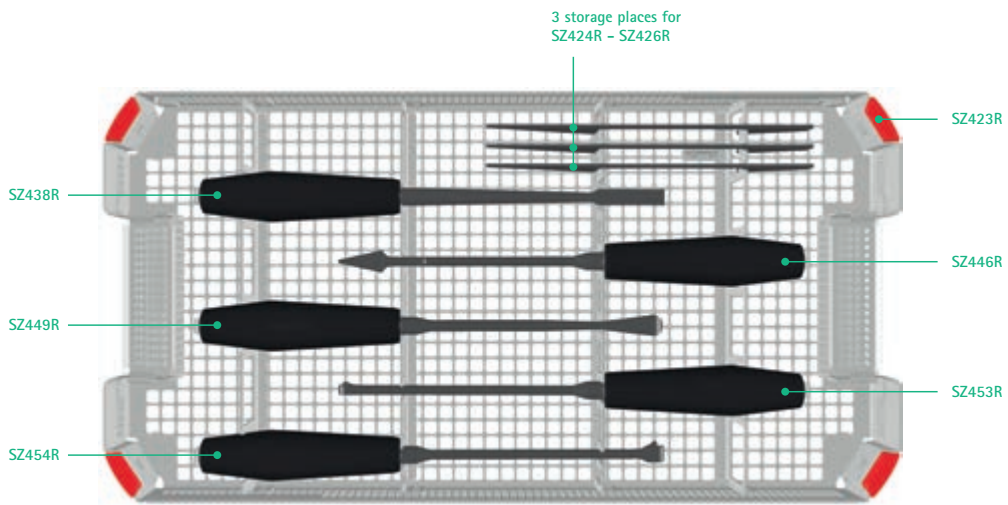

	Art. No.	Description	Qty.
Trays & containers	SZ423R	Ennovate® tray open - Osteotomy optional instruments	1
	JA455R	Lid for ortho tray DIN without handle	1
	JK441	Bottom for 1/1 container height: 120 mm	1
	JK485	Full-size lid with retention plate, red	1
	JG793B	Identification label, purple	4
	TF372	Packing stencil for SZ423R (SZ422)	1

Instruments	SZ424R	Ennovate® angular template, 25°	1
	SZ425R	Ennovate® angular template, 30°	1
	SZ426R	Ennovate® angular template, 35°	1
	SZ438R	Ennovate® osteotome, straight, 18 mm	1
	SZ446R	Ennovate® triangle shaver, 35°	1
	SZ449R	Ennovate® elevator, curved, 13 mm	1
	SZ453R	Ennovate® posterior wall punch, 25 mm	1
	SZ454R	Ennovate® posterior wall punch, 25 mm, large	1

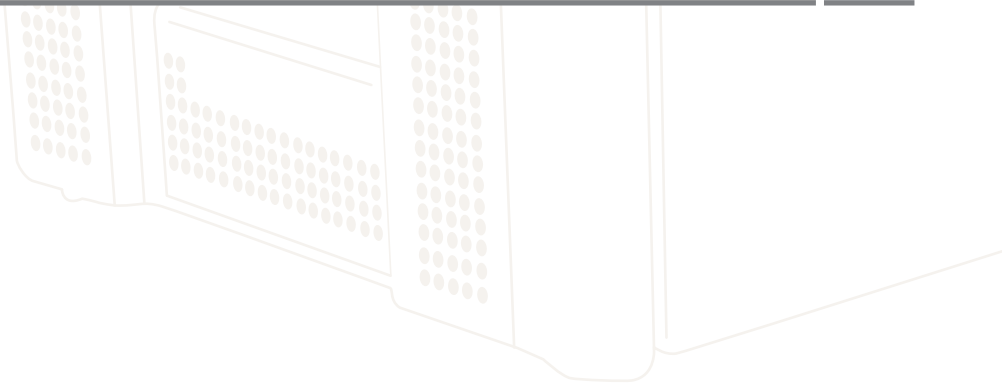

AESCULAP® Ennovate®

5 | SZ486 Ennovate® Set – Preparation and implantation

Minimally invasive

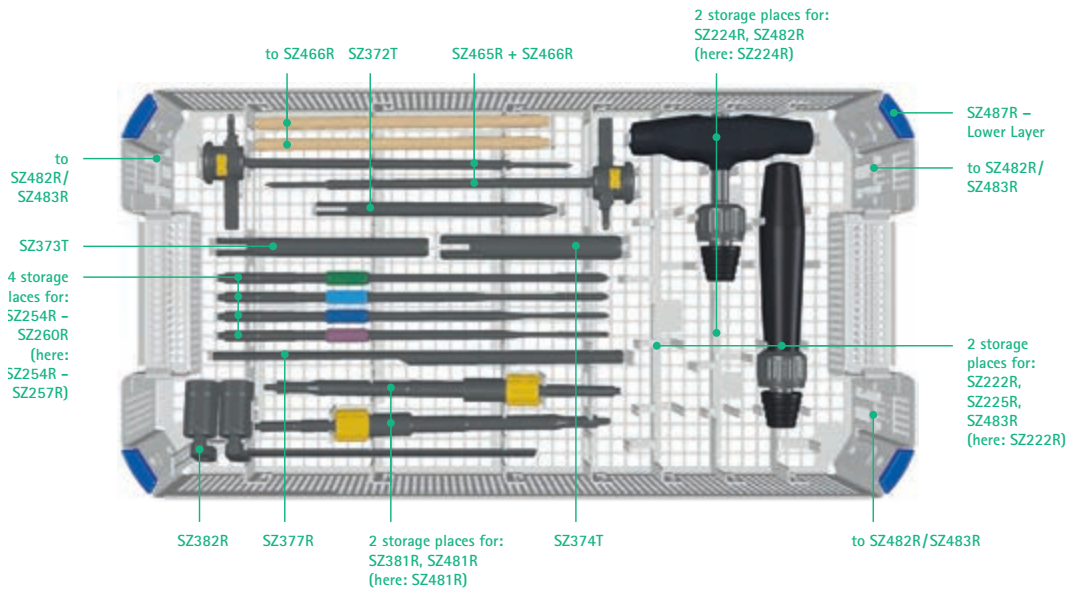

	Art. No.	Description	Qty.
Trays & containers	SZ487R	Ennovate® tray minimally invasive – Preparation and implantation	1
	JA455R	Lid for ortho tray DIN without handle	1
	JK444	Bottom for 1/1 container height: 187 mm	1
	JK486	Full-size lid with retention plate, blue	1
	JG786B	Identification label, blue	4
	TF376	Packing stencil for SZ487R (SZ486)	1

Instruments	SZ222R	Ennovate® ratchet handle, straight	1
	SZ224R	Ennovate® ratchet handle, T shape	1
	SZ465R	Ennovate® guide wire trocar, navigation	2
	SZ466R	Ennovate® guide wire sleeve, navigation	2
	SZ372T	Ennovate® MIS dilator, S	1
	SZ373T	Ennovate® MIS dilator, M	1
	SZ374T	Ennovate® MIS dilator, L	1
	SZ254R	Ennovate® screw tap, Ø 4.5 mm, canulated	1
	SZ255R	Ennovate® screw tap, Ø 5.5 mm, canulated	1
	SZ256R	Ennovate® screw tap, Ø 6.5 mm, canulated	1
	SZ257R	Ennovate® screw tap, Ø 7.5 mm, canulated	1
	SZ377R	Ennovate® MIS screw length measuring device	1
	SZ481R	Ennovate® screwdriver, canulated	2
	SZ382R	Ennovate® MIS/FRI rod length caliper	1
	SZ204R	Ennovate® tray - Guide wires	1
	SZ370	Ennovate® guide wire, nitinol	12

AESCULAP® Ennovate®

5 | SZ486 Ennovate® Set – Preparation and implantation

Minimally invasive

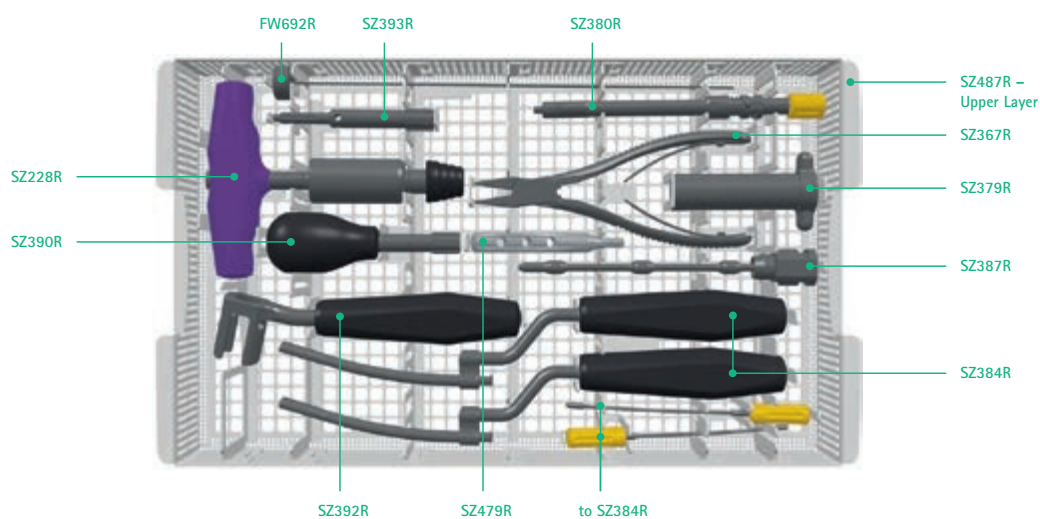

	Art. No.	Description	Qty.
Instruments	FW692R	Ennovate® canulation cleaning device	1
	SZ393R	Ennovate® MIS/FRI downtube PolyLock® key	1
	SZ380R	Ennovate® MIS/FRI downtube removal key	1
	SZ228R	Ennovate® torque handle, 10 Nm	1
	SZ367R	Ennovate® guide wire forceps	1
	SZ379R	Ennovate® MIS/FRI downtube tightening key	1
	SZ390R	Ennovate® reduction handle	1
	SZ387R	Ennovate® MIS/FRI rod indicator	1
	SZ392R	Ennovate® counter torque handle, O shape	1
	SZ384R	Ennovate® MIS/FRI rod inserter, short constructs	2

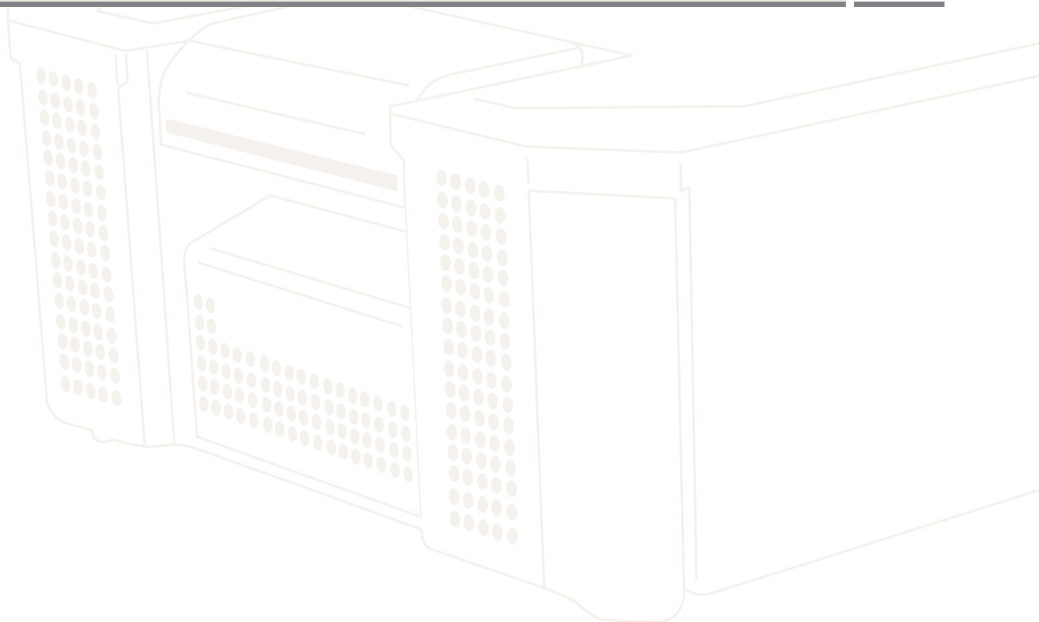

AESULAP® Ennovate®

5 | SZ238 Ennovate® Set – Rod reduction and compression/distraction

Minimally invasive

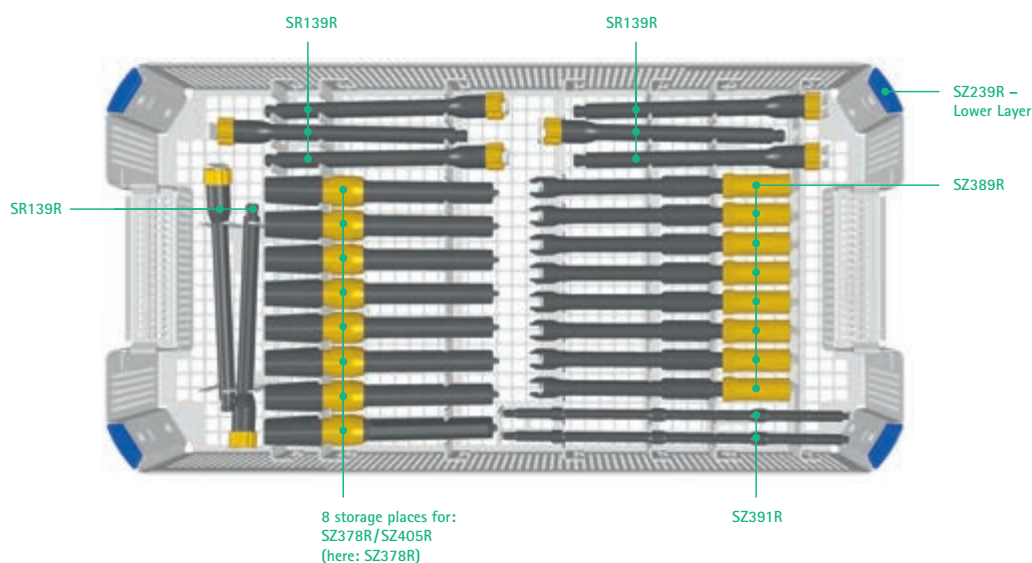

	Art. No.	Description	Qty.
Trays & containers	SZ239R	Ennovate® tray minimally invasive – Rod reduction and compression/distraction	1
	JA455R	Lid for ortho tray DIN without handle	1
	JK444	Bottom for 1/1 container height: 187 mm	1
	JK486	Full-size lid with retention plate, blue	1
	JG786B	Identification label, blue	4
	TF298	Packing stencil for SZ239R (SZ238)	1
Instruments	SZ378R	Ennovate® MIS downtube	6
	SZ389R	Ennovate® MIS rod pusher	6
	SZ391R	Ennovate® set screw driver, with AESULAP® hexagon	2
	SR139R	Ennovate® cannula sleeve, minimally invasive workflow	8

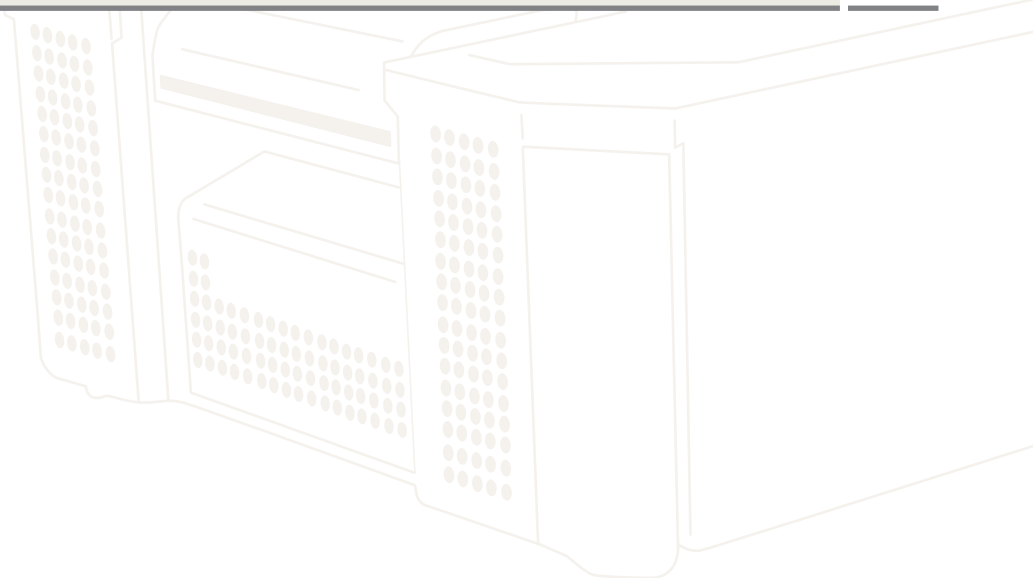

AESCULAP® Ennovate®

5 | SZ238 Ennovate® Set – Rod reduction and compression/distraction

Minimally invasive

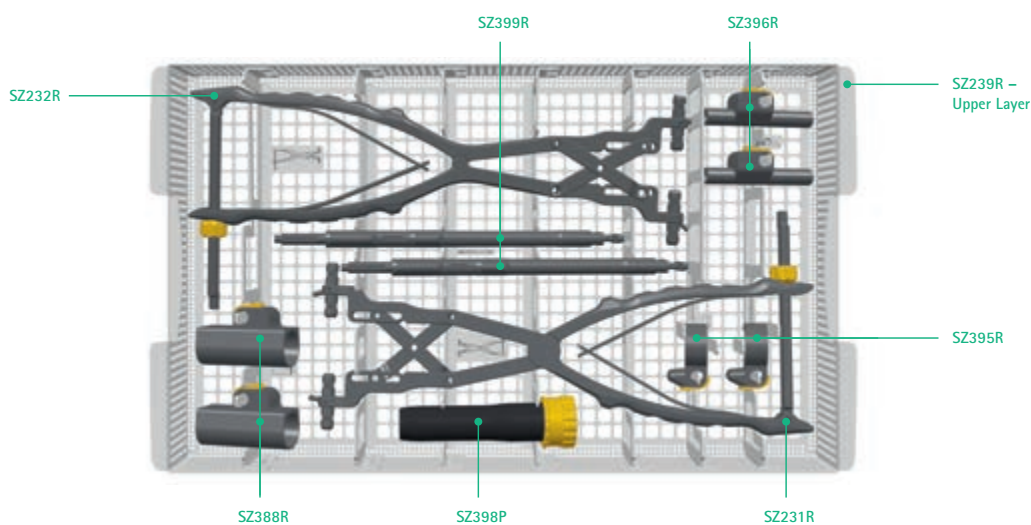

	Art. No.	Description	Qty.
Instruments	SZ231R	Ennovate® MIS/FRI parallel distraction forceps	1
	SZ232R	Ennovate® MIS/FRI parallel compression forceps	1
	SZ388R	Ennovate® MIS/FRI parallel sleeves	2
	SZ395R	Ennovate® MIS/FRI C-rings for compression/distraction device (SZ394T)	2
	SZ396R	Ennovate® MIS cage sleeves	2
	SZ398P	Ennovate® MIS alignment tool working port	1
	SZ399R	Ennovate® MIS alignment tool	2

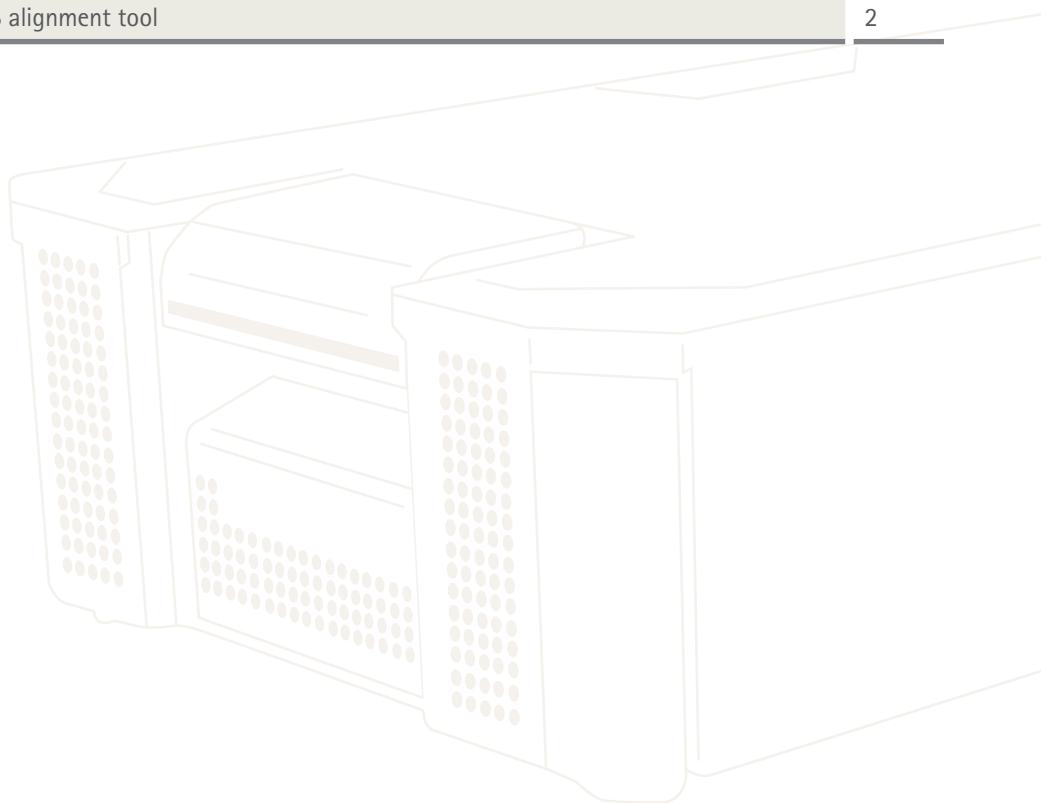

AESULAP® Ennovate®

5 | SZ235 Ennovate® Set – Long constructs instruments

Minimally invasive

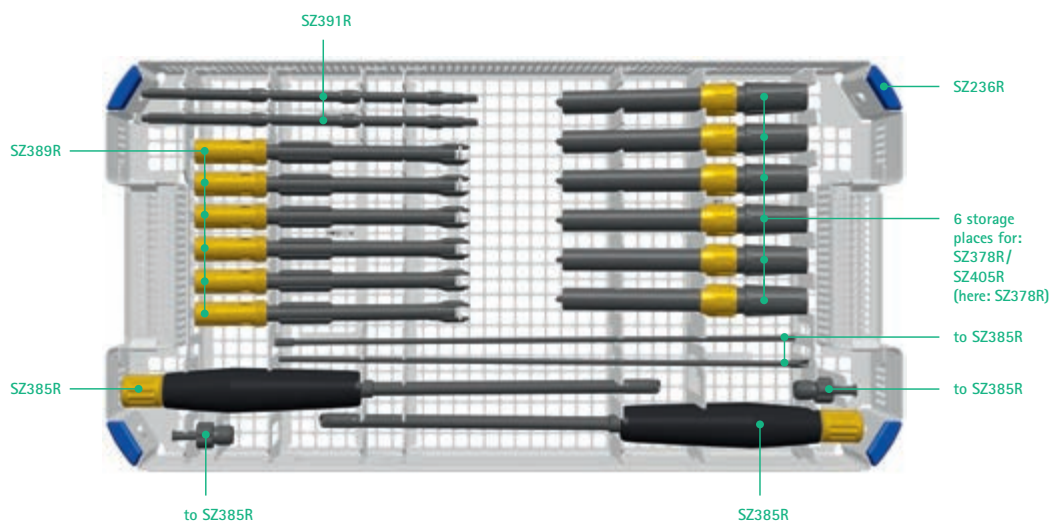

	Art. No.	Description	Qty.
Trays & containers	SZ236R	Ennovate® tray minimally invasive – Long constructs instruments	1
	JA455R	Lid for ortho tray DIN without handle	1
	JK441	Bottom for 1/1 container height: 120 mm	1
	JK486	Full-size lid with retention plate, blue	1
	JG786B	Identification label, blue	4
	TF297	Packing stencil for SZ236R (SZ235)	1
Instruments	SZ378R	Ennovate® MIS downtube	6
	SZ389R	Ennovate® MIS rod pusher	6
	SZ391R	Ennovate® set screw driver, with AESULAP® hexagon	2
	SZ385R	Ennovate® MIS/FRI rod inserter, long constructs	2

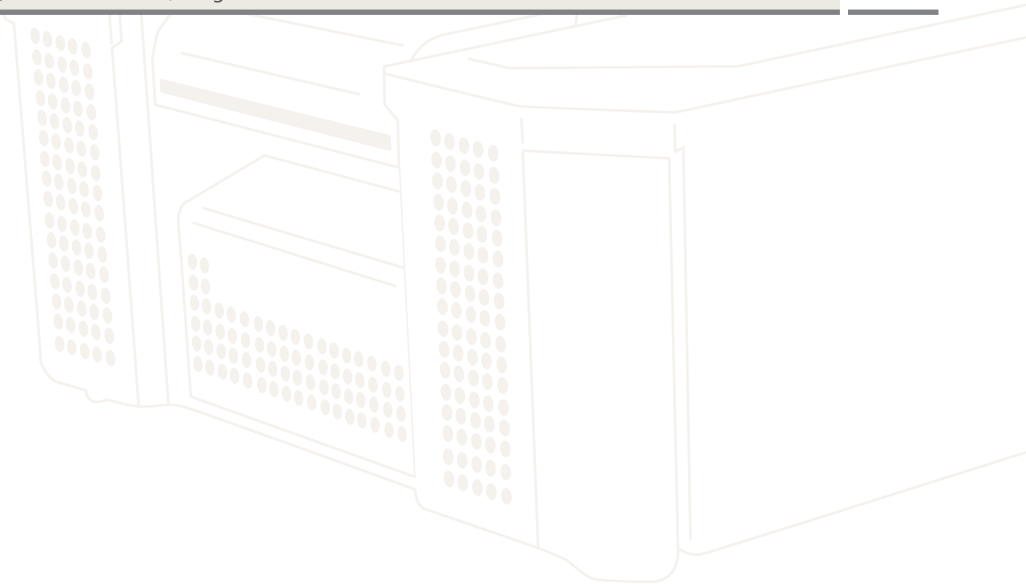

AESCULAP[®] – a B. Braun brand

Aesculap AG | Am Aesculap-Platz | 78532 Tuttlingen | Germany
Phone +49 7461 95-0 | www.bbraun.com

The main product trademark "AESCULAP" and the product trademarks "Ennovate" and "PROSPACE" are registered trademarks of Aesculap AG.

Subject to technical changes. All rights reserved. This brochure may only be used for the exclusive purpose of obtaining information about our products. Reproduction in any form partial or otherwise is not permitted.