

AESCULAP® Ennovate® Thoracolumbar and Sacropelvic

Implant overview

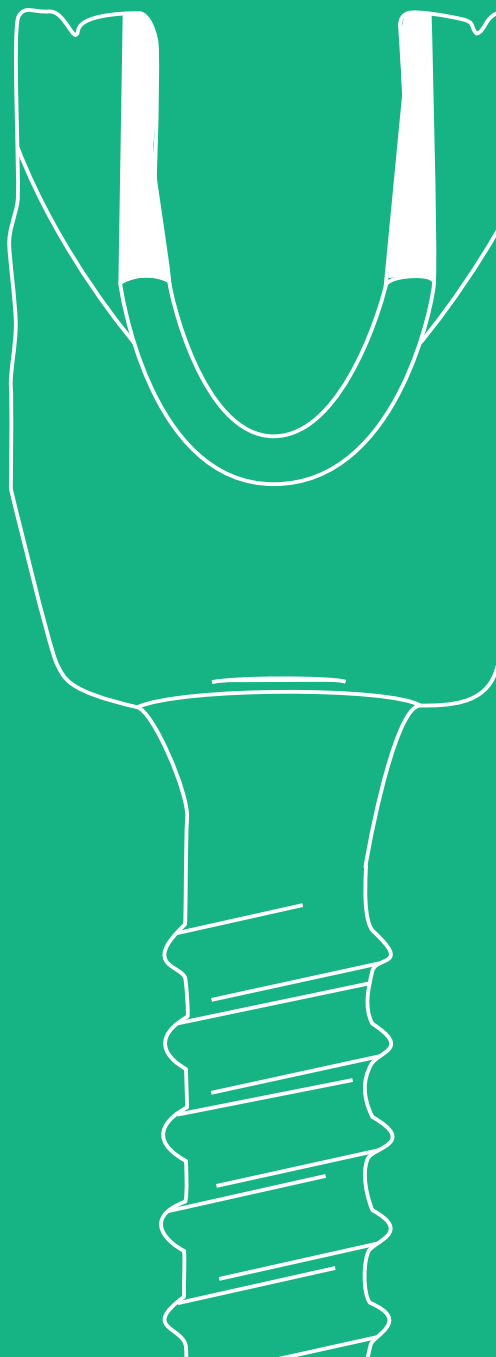

AESCULAP® Ennovate®

Implant overview

1 | Screws

Ennovate® PentaCore® monoaxial screws



Ennovate® PentaCore® polyaxial screws



Ennovate® PentaCore® favored angle screws



Ennovate® PentaCore® uniplanar screws



2 | Rods

Ennovate® Rods, straight

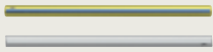

Ennovate® Rods, curved

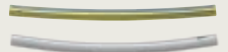

3 | Connectors

Ennovate® Rod connectors, axial



Ennovate® Rod connectors, domino



Ennovate® Rod connectors, lateral offset



Ennovate® Cross connectors, fixed



Ennovate® Cross connectors, adjustable



Ennovate® Cross connectors, multiaxial



4 | Hooks

Ennovate® Pedicle hooks



Ennovate® Lamina hooks, narrow blade



Ennovate® Lamina hooks, wide blade



Ennovate® Lamina hooks, down angled



Ennovate® Lamina hooks, side angled



Ennovate® Lamina hooks, extended body



Ennovate® Lamina hooks, offset



AESCULAP® Ennovate®

1 | Ennovate® PentaCore® monoaxial screws

Length	Type	Ø 4.5 mm	Ø 5.5 mm	Ø 6.5 mm	Ø 7.5 mm	Ø 8.5 mm	Ø 9.5 mm	Ø 10.5 mm
25 mm	solid	SY010TS	SY020TS	SY030TS	SY040TS	-	-	-
	canulated	SY610TS	SY520TS	SY530TS	SY540TS	-	-	-
	fenestrated	-	-	-	-	-	-	-
30 mm	solid	SY011TS	SY021TS	SY031TS	SY041TS	SY051TS	-	-
	canulated	SY511TS	SY521TS	SY531TS	SY541TS	SY551TS	-	-
	fenestrated	-	-	-	-	-	-	-
35 mm	solid	SY012TS	SY022TS	SY032TS	SY042TS	SY052TS	SY062TS	SY072TS
	canulated	SY512TS	SY522TS	SY532TS	SY542TS	SY552TS	SY562TS	SY572TS
	fenestrated	-	SY722TS	SY732TS	SY742TS	SY752TS	SY762TS	SY772TS
40 mm	solid	SY013TS	SY023TS	SY033TS	SY043TS	SY053TS	SY063TS	SY073TS
	canulated	SY513TS	SY523TS	SY533TS	SY543TS	SY553TS	SY563TS	SY573TS
	fenestrated	-	SY723TS	SY733TS	SY743TS	SY753TS	SY763TS	SY773TS
45 mm	solid	SY014TS	SY024TS	SY034TS	SY044TS	SY054TS	SY064TS	SY074TS
	canulated	SY514TS	SY524TS	SY534TS	SY544TS	SY554TS	SY564TS	SY574TS
	fenestrated	-	SY724TS	SY734TS	SY744TS	SY754TS	SY764TS	SY774TS
50 mm	solid	SY015TS	SY025TS	SY035TS	SY045TS	SY055TS	SY065TS	SY075TS
	canulated	SY515TS	SY525TS	SY535TS	SY545TS	SY555TS	SY565TS	SY575TS
	fenestrated	-	SY725TS	SY735TS	SY745TS	SY755TS	SY765TS	SY775TS
55 mm	solid	-	-	SY036TS	SY046TS	SY056TS	SY066TS	SY076TS
	canulated	-	-	SY536TS	SY546TS	SY556TS	SY566TS	SY576TS
	fenestrated	-	-	SY736TS	SY746TS	SY756TS	SY766TS	SY776TS
60 mm	solid	-	-	SY037TS	SY047TS	SY057TS	SY067TS	SY077TS
	canulated	-	-	SY537TS	SY547TS	SY557TS	SY567TS	SY577TS
	fenestrated	-	-	SY737TS	SY747TS	SY757TS	SY767TS	SY777TS
70 mm	solid	-	-	SY038TS	SY048TS	SY058TS	SY068TS	SY078TS
	canulated	-	-	SY538TS	SY548TS	SY558TS	SY568TS	SY578TS
	fenestrated	-	-	SY738TS	SY748TS	SY758TS	SY768TS	SY778TS
80 mm	solid	-	-	SY039TS	SY049TS	SY059TS	SY069TS	SY079TS
	canulated	-	-	SY539TS	SY549TS	SY559TS	SY569TS	SY579TS
	fenestrated	-	-	SY739TS	SY749TS	SY759TS	SY769TS	SY779TS

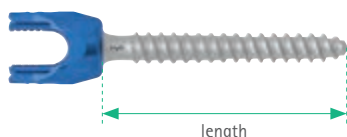

Ennovate® Set screw
 SY001TS Single pack
 SY002TS 10-pack

AESCULAP® Ennovate®

1 | Ennovate® PentaCore® polyaxial screws

Length	Type	Ø 4.5 mm	Ø 5.5 mm	Ø 6.5 mm	Ø 7.5 mm	Ø 8.5 mm	Ø 9.5 mm	Ø 10.5 mm
25 mm	solid	SY110TS	SY120TS	SY130TS	SY140TS	-	-	-
	canulated	SY610TS	SY620TS	SY630TS	SY640TS	-	-	-
	fenestrated	-	-	-	-	-	-	-
30 mm	solid	SY111TS	SY121TS	SY131TS	SY141TS	SY151TS	-	-
	canulated	SY611TS	SY621TS	SY631TS	SY641TS	SY651TS	-	-
	fenestrated	-	-	-	-	-	-	-
35 mm	solid	SY112TS	SY122TS	SY132TS	SY142TS	SY152TS	SY162TS	SY172TS
	canulated	SY612TS	SY622TS	SY632TS	SY642TS	SY652TS	SY662TS	SY672TS
	fenestrated	-	SY822TS	SY832TS	SY842TS	SY852TS	SY862TS	SY872TS
40 mm	solid	SY113TS	SY123TS	SY133TS	SY143TS	SY153TS	SY163TS	SY173TS
	canulated	SY613TS	SY623TS	SY633TS	SY643TS	SY653TS	SY663TS	SY673TS
	fenestrated	-	SY823TS	SY833TS	SY843TS	SY853TS	SY863TS	SY873TS
45 mm	solid	SY114TS	SY124TS	SY134TS	SY144TS	SY154TS	SY164TS	SY174TS
	canulated	SY614TS	SY624TS	SY634TS	SY644TS	SY654TS	SY664TS	SY674TS
	fenestrated	-	SY824TS	SY834TS	SY844TS	SY854TS	SY864TS	SY874TS
50 mm	solid	SY115TS	SY125TS	SY135TS	SY145TS	SY155TS	SY165TS	SY175TS
	canulated	SY615TS	SY625TS	SY635TS	SY645TS	SY655TS	SY665TS	SY675TS
	fenestrated	-	SY825TS	SY835TS	SY845TS	SY855TS	SY865TS	SY875TS
55 mm	solid	-	-	SY136TS	SY146TS	SY156TS	SY166TS	SY176TS
	canulated	-	-	SY636TS	SY646TS	SY656TS	SY666TS	SY676TS
	fenestrated	-	-	SY836TS	SY846TS	SY856TS	SY866TS	SY876TS
60 mm	solid	-	-	SY137TS	SY147TS	SY157TS	SY167TS	SY177TS
	canulated	-	-	SY637TS	SY647TS	SY657TS	SY667TS	SY677TS
	fenestrated	-	-	SY837TS	SY847TS	SY857TS	SY867TS	SY877TS
70 mm	solid	-	-	SY138TS	SY148TS	SY158TS	SY168TS	SY178TS
	canulated	-	-	SY638TS	SY648TS	SY658TS	SY668TS	SY678TS
	fenestrated	-	-	SY838TS	SY848TS	SY858TS	SY868TS	SY878TS
80 mm	solid	-	-	SY139TS	SY149TS	SY159TS	SY169TS	SY179TS
	canulated	-	-	SY639TS	SY649TS	SY659TS	SY669TS	SY679TS
	fenestrated	-	-	SY839TS	SY849TS	SY859TS	SY869TS	SY879TS
90 mm	solid	-	-	-	SY188TS	SY191TS	SY194TS	SY197TS
	canulated	-	-	-	SY688TS	SY691TS	SY694TS	SY697TS
	fenestrated	-	-	-	-	-	-	-
100 mm	solid	-	-	-	SY189TS	SY192TS	SY195TS	SY198TS
	canulated	-	-	-	SY689TS	SY692TS	SY695TS	SY698TS
	fenestrated	-	-	-	-	-	-	-
110 mm	solid	-	-	-	SY190TS	SY193TS	SY196TS	SY199TS
	canulated	-	-	-	SY690TS	SY693TS	SY696TS	SY699TS
	fenestrated	-	-	-	-	-	-	-

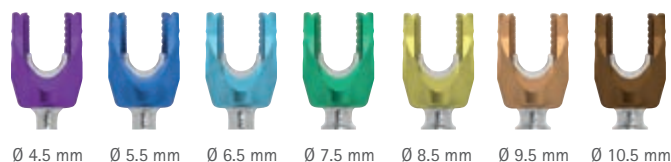
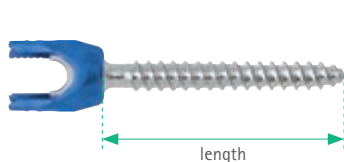

Ennovate® Set screw
SY001TS Single pack
SY002TS 10-pack

AESCULAP® Ennovate®

1 | Ennovate® PentaCore® favored angle screws

Length	Type	Ø 4.5 mm	Ø 5.5 mm	Ø 6.5 mm	Ø 7.5 mm	Ø 8.5 mm	Ø 9.5 mm	Ø 10.5 mm
25 mm	solid	SY310TS	SY120TS	SY330TS	SY340TS	-	-	-
	canulated	SY1310TS	SY1320TS	SY1330TS	SY1340TS	-	-	-
30 mm	solid	SY311TS	SY321TS	SY331TS	SY341TS	SY151TS	-	-
	canulated	SY1311TS	SY1321TS	SY1331TS	SY1341TS	SY1351TS	-	-
35 mm	solid	SY312TS	SY322TS	SY332TS	SY342TS	SY352TS	SY362TS	SY372TS
	canulated	SY1312TS	SY1322TS	SY1332TS	SY1342TS	SY1352TS	SY1362TS	SY1372TS
40 mm	solid	SY313TS	SY323TS	SY333TS	SY343TS	SY353TS	SY363TS	SY373TS
	canulated	SY1313TS	SY1323TS	SY1333TS	SY1343TS	SY1353TS	SY1363TS	SY1373TS
45 mm	solid	SY314TS	SY324TS	SY334TS	SY344TS	SY354TS	SY364TS	SY374TS
	canulated	SY1314TS	SY1324TS	SY1334TS	SY1344TS	SY1354TS	SY1364TS	SY1374TS
50 mm	solid	SY315TS	SY325TS	SY335TS	SY345TS	SY355TS	SY365TS	SY375TS
	canulated	SY1315TS	SY1325TS	SY1335TS	SY1345TS	SY1355TS	SY1365TS	SY1375TS
55 mm	solid	-	-	SY336TS	SY346TS	SY356TS	SY366TS	SY376TS
	canulated	-	-	SY1336TS	SY1346TS	SY1356TS	SY1366TS	SY1376TS
60 mm	solid	-	-	SY337TS	SY347TS	SY357TS	SY367TS	SY377TS
	canulated	-	-	SY1337TS	SY1347TS	SY1357TS	SY1367TS	SY1377TS
70 mm	solid	-	-	SY338TS	SY348TS	SY358TS	SY368TS	SY378TS
	canulated	-	-	SY1338TS	SY1348TS	SY1358TS	SY1368TS	SY1378TS
80 mm	solid	-	-	SY339TS	SY349TS	SY359TS	SY369TS	SY379TS
	canulated	-	-	SY1339TS	SY1349TS	SY1359TS	SY1369TS	SY1379TS
90 mm	solid	-	-	-	SY388TS	SY391TS	SY394TS	SY397TS
	canulated	-	-	-	SY1388TS	SY1391TS	SY1394TS	SY1397TS
100 mm	solid	-	-	-	SY389TS	SY392TS	SY395TS	SY398TS
	canulated	-	-	-	SY1389TS	SY1392TS	SY1395TS	SY1398TS
110 mm	solid	-	-	-	SY390TS	SY393TS	SY396TS	SY399TS
	canulated	-	-	-	SY1390TS	SY1393TS	SY1396TS	SY1399TS

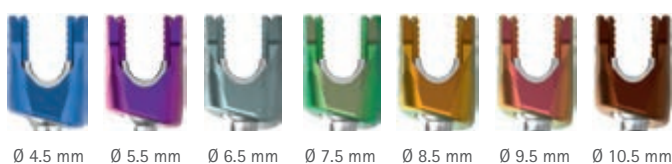
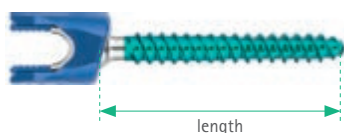

Ennovate® Set screw
 SY001TS Single pack
 SY002TS 10-pack

AESCULAP® Ennovate®

1 | Ennovate® PentaCore® uniplanar screws

Length	Type	Ø 4.5 mm	Ø 5.5 mm	Ø 6.5 mm	Ø 7.5 mm	Ø 8.5 mm	Ø 9.5 mm	Ø 10.5 mm
25 mm	solid	SY210TS	SY220TS	SY230TS	SY240TS	-	-	-
	canulated	SY1210TS	SY1220TS	SY1230TS	SY1240TS	-	-	-
30 mm	solid	SY211TS	SY221TS	SY231TS	SY241TS	SY251TS	-	-
	canulated	SY1211TS	SY1221TS	SY1231TS	SY1241TS	SY1251TS	-	-
35 mm	solid	SY212TS	SY222TS	SY232TS	SY242TS	SY252TS	SY262TS	SY272TS
	canulated	SY1212TS	SY1222TS	SY1232TS	SY1242TS	SY1252TS	SY1262TS	SY1272TS
40 mm	solid	SY213TS	SY223TS	SY233TS	SY243TS	SY253TS	SY263TS	SY273TS
	canulated	SY1213TS	SY1223TS	SY1233TS	SY1243TS	SY1253TS	SY1263TS	SY1273TS
45 mm	solid	SY214TS	SY224TS	SY234TS	SY244TS	SY254TS	SY264TS	SY274TS
	canulated	SY1214TS	SY1224TS	SY1234TS	SY1244TS	SY1254TS	SY1264TS	SY1274TS
50 mm	solid	SY215TS	SY225TS	SY235TS	SY245TS	SY255TS	SY265TS	SY275TS
	canulated	SY1215TS	SY1225TS	SY1235TS	SY1245TS	SY1255TS	SY1265TS	SY1275TS
55 mm	solid	-	-	SY236TS	SY246TS	SY256TS	SY266TS	SY276TS
	canulated	-	-	SY1236TS	SY1246TS	SY1256TS	SY1266TS	SY1276TS
60 mm	solid	-	-	SY237TS	SY247TS	SY257TS	SY267TS	SY277TS
	canulated	-	-	SY1237TS	SY1247TS	SY1257TS	SY1267TS	SY1277TS
70 mm	solid	-	-	SY238TS	SY248TS	SY258TS	SY268TS	SY278TS
	canulated	-	-	SY1238TS	SY1248TS	SY1258TS	SY1268TS	SY1278TS
80 mm	solid	-	-	SY239TS	SY249TS	SY259TS	SY269TS	SY279TS
	canulated	-	-	SY1239TS	SY1249TS	SY1259TS	SY1269TS	SY1279TS

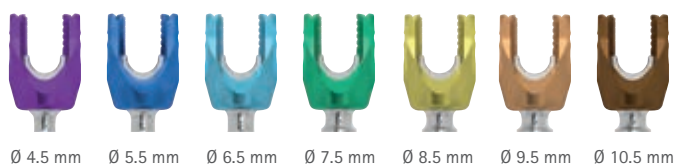
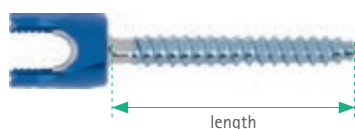

Ennovate® Set screw
SY001TS Single pack
SY002TS 10-pack

AESCULAP® Ennovate®

2 | Ennovate® Rods, straight

Length	Type	Open	MIS
30 mm	Ti alloy	SY400TS	SY900TS
	CoCr alloy	SY452KS	SY952KS
35 mm	Ti alloy	SY401TS	SY901TS
	CoCr alloy	SY451KS	SY951KS
40 mm	Ti alloy	SY402TS	SY902TS
	CoCr alloy	SY452KS	SY952KS
45 mm	Ti alloy	SY403TS	SY903TS
	CoCr alloy	SY453KS	SY953KS
50 mm	Ti alloy	SY404TS	SY904TS
	CoCr alloy	SY454KS	SY954KS
55 mm	Ti alloy	SY405TS	SY905TS
	CoCr alloy	SY455KS	SY955KS
60 mm	Ti alloy	SY406TS	SY906TS
	CoCr alloy	SY456KS	SY956KS
70 mm	Ti alloy	SY407TS	SY907TS
	CoCr alloy	SY457KS	SY957KS
80 mm	Ti alloy	SY408TS	SY908TS
	CoCr alloy	SY458KS	SY958KS
90 mm	Ti alloy	SY409TS	SY909TS
	CoCr alloy	SY459KS	SY959KS
100 mm	Ti alloy	SY410TS	SY910TS
	CoCr alloy	SY460KS	SY960KS
110 mm	Ti alloy	SY411TS	SY911TS
	CoCr alloy	SY461KS	SY961KS

Length	Type	Open	MIS
120 mm	Ti alloy	SY412TS	SY912TS
	CoCr alloy	SY462KS	SY962KS
130 mm	Ti alloy	SY413TS	SY913TS
	CoCr alloy	SY463KS	SY963KS
140 mm	Ti alloy	SY414TS	SY914TS
	CoCr alloy	SY464KS	SY964KS
150 mm	Ti alloy	SY415TS	SY915TS
	CoCr alloy	SY465KS	SY965KS
160 mm	Ti alloy	SY416TS	SY916TS
	CoCr alloy	SY466KS	SY966KS
170 mm	Ti alloy	SY417TS	SY917TS
	CoCr alloy	SY467KS	SY967KS
180 mm	Ti alloy	SY418TS	SY918TS
	CoCr alloy	SY468KS	SY968KS
190 mm	Ti alloy	SY419TS	SY919TS
	CoCr alloy	SY469KS	SY969KS
200 mm	Ti alloy	SY420TS	SY920TS
	CoCr alloy	SY470KS	SY970KS
300 mm	Ti alloy	SY421TS	SY921TS
	CoCr alloy	SY471KS	SY971KS
400 mm	Ti alloy	SY422TS	SY922TS
	CoCr alloy	SY472KS	SY972KS
500 mm	Ti alloy	SY423TS	SY923TS
	CoCr alloy	SY473KS	SY973KS

30 - 150 mm, open workflows



Titanium alloy



Cobalt chrome alloy

160 - 500 mm, open workflows



Titanium alloy



Cobalt chrome alloy

30 - 500 mm, minimally invasive workflows



Titanium alloy



Cobalt chrome alloy

AESCULAP® Ennovate®

2 | Ennovate® Rods, curved

Length	Type	Open	MIS
30 mm	Ti alloy	SY430TS	SY930TS
	CoCr alloy	SY480KS	SY980KS
35 mm	Ti alloy	SY431TS	SY931TS
	CoCr alloy	SY481KS	SY951KS
40 mm	Ti alloy	SY432TS	SY902TS
	CoCr alloy	SY482KS	SY982KS
45 mm	Ti alloy	SY433TS	SY933TS
	CoCr alloy	SY483KS	SY983KS
50 mm	Ti alloy	SY434TS	SY9334TS
	CoCr alloy	SY484KS	SY984KS
55 mm	Ti alloy	SY435TS	SY935TS
	CoCr alloy	SY485KS	SY985KS
60 mm	Ti alloy	SY436TS	SY936TS
	CoCr alloy	SY486KS	SY986KS
70 mm	Ti alloy	SY437TS	SY937TS
	CoCr alloy	SY487KS	SY987KS

Length	Type	Open	MIS
80 mm	Ti alloy	SY438TS	SY938TS
	CoCr alloy	SY458KS	SY958KS
90 mm	Ti alloy	SY439TS	SY939TS
	CoCr alloy	SY489KS	SY989KS
100 mm	Ti alloy	SY440TS	SY940TS
	CoCr alloy	SY490KS	SY990KS
110 mm	Ti alloy	SY441TS	SY941TS
	CoCr alloy	SY491KS	SY991KS
120 mm	Ti alloy	SY442TS	SY942TS
	CoCr alloy	SY492KS	SY992KS
130 mm	Ti alloy	SY443TS	SY943TS
	CoCr alloy	SY493KS	SY993KS
140 mm	Ti alloy	SY444TS	SY944TS
	CoCr alloy	SY494KS	SY994KS
150 mm	Ti alloy	SY445TS	SY945TS
	CoCr alloy	SY495KS	SY995KS

30 - 150 mm, open workflows



Titanium alloy

Cobalt chrome alloy

30 - 150 mm, minimally invasive workflows



Titanium alloy

Cobalt chrome alloy

AESCULAP® Ennovate®

3 | Ennovate® Cross connectors

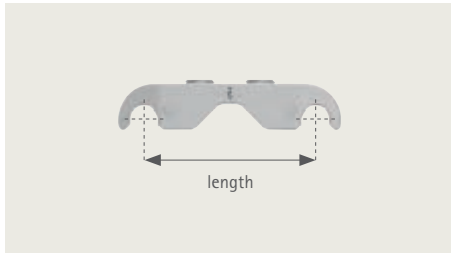

Cross connectors, fixed	
30 mm	SX942TS
32 mm	SX943TS
34 mm	SX944TS
36 mm	SX945TS
38 mm	SX946TS
40 mm	SX947TS

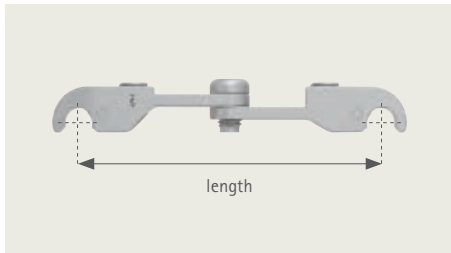

Cross connectors, adjustable	
42 - 45 mm	SX948TS
45 - 50 mm	SX949TS
50 - 60 mm	SX950TS
60 - 80 mm	SX951TS
80 - 100 mm	SX952TS

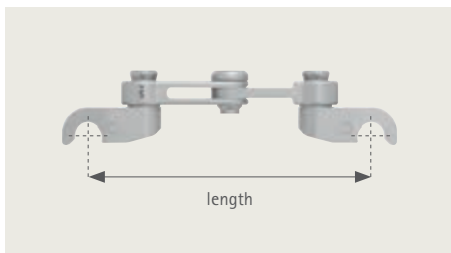

Cross connectors, multiaxial	
26 - 30 mm	SX932TS
28 - 34 mm	SX933TS
31 - 37 mm	SX934TS
34 - 40 mm	SX935TS
39 - 45 mm	SX936TS
45 - 58 mm	SX937TS
58 - 80 mm	SX938TS
80 - 100 mm	SX939TS

AESCULAP® Ennovate®

3 | Ennovate® Rod connectors

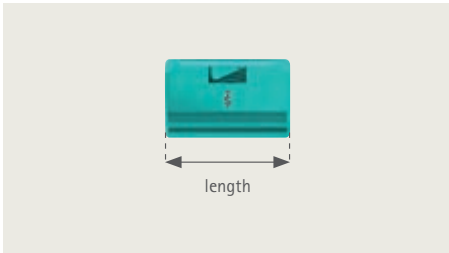

Rod connectors, axial	
19 mm	SY701TS
34 mm	SY702TS

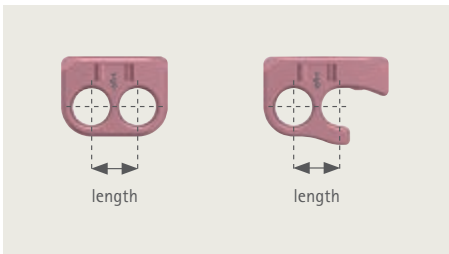

Rod connectors, domino		
	Closed	Open/closed
7 mm	SY703TS	SY706TS
11 mm	SY704TS	SY706TS

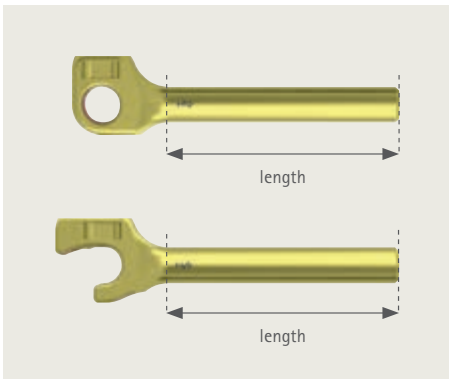

Rod connectors, lateral offset		
	Closed	Open
20 mm	SY711TS	SY716TS
35 mm	SY712TS	SY717TS
50 mm	SY713TS	SY718TS

AESCULAP® Ennovate®

4 | Ennovate® Hooks



Pedicle hooks

small	SY801TS
medium	SY802TS
large	SY803TS



Lamina hooks, narrow blade

small	SY804TS
medium	SY805TS
small groove	SY808TS
large groove	SY809TS



Lamina hooks, wide blade

small	SY806TS
medium	SY807TS
small groove	SY810TS
large groove	SY811TS



Lamina hooks, down angled

small	SY812TS
medium	SY813TS
left	SY814TS
right	SY815TS



Lamina hooks, side angled

left	SY814TS
right	SY815TS



Lamina hooks, extended body

small	SY816TS
medium	SY817TS
large	SY818TS



Lamina hooks, offset

left	SY819TS
right	SY820TS

AESFULAP[®] – a B. Braun brand

Aesculap AG | Am Aesculap-Platz | 78532 Tuttlingen | Germany
Phone +49 7461 95-0 | www.bbraun.com

The main product trademark "AESFULAP" and the product trademarks "Ennovate" and "PentaCore" are registered trademarks of Aesculap AG.

Subject to technical changes. All rights reserved. This brochure may only be used for the exclusive purpose of obtaining information about our products. Reproduction in any form partial or otherwise is not permitted.